

THE

RADIO CONSTRUCTOR

Vol. 22 No. 2

OCTOBER 1968

3/-

A DATA PUBLICATION

RADIO · TELEVISION · ELECTRONICS · AUDIO

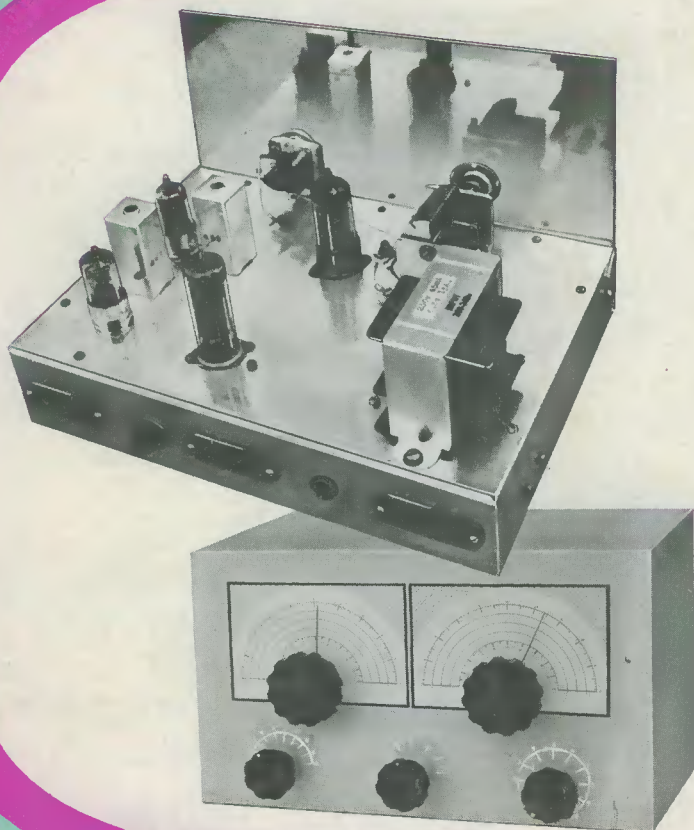

**BANDSPREAD
H.F. BANDS
SUPERHET**

Also featured

Infinite Resistance
Voltmeter



Crystal Microphone
Matching Unit



Light Operated
Switches

Scottish Insurance Corporation Ltd

66-67 CORNHILL · LONDON · EC3



*TELEVISION
SETS,
RECEIVERS
AND
TRANSMITTERS*

Television Sets, Receivers and Short Wave Transmitters are expensive to acquire and you no doubt highly prize your installation. Apart from the value of your Set, you might be held responsible should injury be caused by a fault in the Set, or injury or damage by your Aerial collapsing.

A "Scottish" special policy for Television Sets, Receivers and Short Wave Transmitters provides the following cover:

- (a) Loss or damage to installation (including in the case of Television Sets the Cathode Ray Tube) by Fire, Explosion, Lightning, Theft or Accidental External Means at any private dwelling-house.
- (b) (i) Legal Liability for bodily injury to Third Parties or damage to their property arising out of the breakage or collapse of the Aerial Fittings or Mast, or through any defect in the Set. Indemnity £10,000 any one accident.
- (ii) Damage to your property or that of your landlord arising out of the breakage or collapse of the Aerial Fittings or Mast, but not exceeding £500.

Why not BE PRUDENT AND INSURE your installation—it is well worthwhile AT THE VERY LOW COST INVOLVED. If you write to the Corporation's Office a proposal will be submitted for completion.

Write for full details, quoting reference 5304, to:—

THE MANAGER
SCOTTISH INSURANCE CORPORATION LTD.,
66-67 CORNHILL, LONDON E.C.3

BI-PAK SEMICONDUCTORS

500 Chesham House
150 Regent Street
London W.1.

KING OF THE PAKS SATISFACTION GUARANTEED
SUPER PAKS—BRAND NEW
Untested Semiconductors

QUALITY-TESTED VALUE PAKS ★ BARGAINS

2 Drift Trans. 2N1225 Germ. PNP 100 Mc/s	10/-	4 Silicon Rects. 100 PIV 750mA	10/-
6 Matched Trans. OC44/45/81/81D	10/-	3 AF117 Trans. Mullard Type	10/-
16 Red Spot AF Trans. PNP	10/-	7 OC81 Type Trans.	10/-
16 White Spot RF Trans. PNP	10/-	3 OC171 Trans. Mullard Type	10/-
5 Silicon Rects. 3A 100-400 PIV	10/-	3 2N926 Sil. Epoxy Trans.	10/-
2 10 A Silicon Rects. 100 PIV	10/-	7 OC71 Type Trans.	10/-
2 OC140 Trans. NPN Switching	10/-	25 Trans. Heatsinks fit TO18, TO11	10/-
1 12 A SCR 100 PIV	10/-	2 25701 Sil. Trans. Texas	10/-
3 Sil. Trans. 25303 PNP	10/-	3 12 Volt Zeners 400mW	10/-
4 Zener Diodes 250mW 3-12V	10/-	2 10 A 600 PIV Sil. Rects. IS425R	10/-
3 200 Mc s Sil. Trans. NPN BSY26/27	10/-	3 BC108 Sil. NPN High Gain Trans.	15/-
3 Zener Diodes 400mW 33V 5% Tol.	10/-	1 2N910 NPN Sil. Trans. VCB100	15/-
4 High Current Trans. OC42 Evt.	10/-	80 Mc/s	15/-
2 Power Transistors 1 OC26 1 OC35	10/-	2 1000 PIV Sil. Rect. 1.5 A RS310 AF	15/-
5 Silicon Rects. 400 PIV 250mA	10/-	3 BSY95A Sil. Trans. NPN 200 Mc/s	15/-
4 OC75 Transistors Mullard Type	10/-	3 OC200 Sil. Trans. Mullard	15/-
1 Power Trans. OC20 100V	10/-	2 Sil. Power Rects. BYZ13	15/-
4 OA202 Sil. Diodes Sub-min.	10/-	1 Sil. Power Trans. NPN100 Mc/s	15/-
2 Low Noise Trans. NPN 2N929/30	10/-	1 TK201A	15/-
1 Sil. Trans. NPN VCB 100 ZT86	10/-	6 Zener Diodes 3-15V Sub-min.	15/-
8 OA81 Diodes	10/-	1 2N1132 PNP Epitaxial Planar Sil. Trans.	15/-
4 OC72 Transistors Mullard Type	10/-	3 2N697 Epitaxial Planar Trans. Sil.	15/-
4 OC77 Transistors Mullard Type	10/-	4 Germ. Power Trans. Evt. OC16 Mullard	15/-
5 Metal Alloy Transistors Mat. Type	10/-	1 Unijunction Trans. 2N2646	15/-
4 Sil. Rects. 400 PIV 500mA	10/-	2 Sil. Trans. 200 Mc/s 60Vcb ZT83/84	15/-
5 GET884 Trans. Evt. OC44	10/-	1 Sil. Planar Trans. NPN 100 Mc/s BSY25	15/-
5 GET883 Trans. Evt. OC45	10/-	1 Tunnel Diode IN3720 (TDS) G.E.	15/-
2 2N708 Sil. Trans. 300 Mc/s NPN	10/-	1 Unijunction Trans. 2N2160 TO-5 can G.E.	15/-
5 OT41/45 Germ. Trans. PNP Evt. OC71	10/-	2 Sil. Rects. 5 A 400 PIV Stud Type	15/-
3 GT31 LF Low Noise Germ. Trans. PNP	10/-	2 Germ. Power Trans. OC28/29	15/-
6 IN914 Sil. Diodes 75 PIV 75mA	10/-	1 10 A Sil. Stud Rect. 800 PIV	15/-
8 OA95 Germ. Diodes Sub-min.	10/-	1 Tunnel Diode AEY111 1050 Mc/s	15/-
3 NPN Germ. Trans. NKT773 Evt. AC130	10/-	2 2N212 Sil. Epoxy Planar HFE225 max.	15/-
2 OC22 Power Trans. Germ.	10/-	6 BY 100 Type Sil. Rects.	20/-
2 OC25 Power Trans. Germ.	10/-	25 Sil. and Germ. Trans. Mixed, all marked New	30/-
2 OC73 Mullard Trans.	10/-	10 New Power Trans. GEC replaces OC16/26/28	30/-
4 AC128 Trans. PNP High Gain	10/-	4 OA10 Diodes Mullard	30/-
2 AC127/128 Comp. pair PNP/NPN	10/-		
3 2N1307 PNP Switching Trans.	10/-		
7 CG62H Germ. Diodes Evt. OA71	10/-		
3 AF116 Mullard Type Trans.	10/-		
12 Assorted Germ. Diodes Marked	10/-		
4 AC126 Germ. PNP Trans.	10/-		
1 ORP61 Photo-conductive cell	10/-		

UNIUNCTION
UT46, Evt. 2N2646.
Evt. T1S43. BEN3000
7/6 EACH

SIL. RECTS TESTED

PIV	750mA	3A	10A	30A
50	2/	3/	4/6	9/6
100	2/3	3/6	6/	15/
200	2/6	4/6	6/6	20/
300	3/	4/9	8/	22/
400	3/6	6/	9/	25/
500	4/	6/6	9/6	30/
600	4/3	7/	10/	37/
800	4/9	8/	15/	40/
1000	6/	10/	17/6	50/

SCR's

LOWEST PRICE LARGEST RANGE

PIV	1AMP	7A	16A	30A
25	—	7/6	—	30/
50	7/6	8/6	10/6	35/
100	8/6	10/	15/	45/
200	12/6	15/	20/	55/
300	15/	20/	25/	—
400	17/6	25/	35/	80/
500	30/	40/	45/	95/
600	35/	40/	50/	—

CADMIUM CELLS
ORP12, ORP60 8/6 each

PRINTED CIRCUITS
Ex-Computer
Packed with semi-conductors and components. 10 boards give a guaranteed 30 trans. and 30 diodes. Our price 10 boards 10/- plus 2/- p.p.

INTEGRATED CIRCUITS
Epoxy TO5 8 lead
µL 900 Buffer 11/-
µL 914 Dual Gate 11/-
µL 923 J-K Flip Flop 14/-
ICircuits data etc 1/6 Mullard TAA263
Lin Amp 21/-
TAA243 70/-
TAA293 26/-

PAK NO.

U1	120 Glass Sub-min General Purpose Germanium Diodes	10/-
U2	60 Mixed Germanium Transistors AF/RF	10/-
U3	75 Germanium Gold Bonded Diodes Sub-min Sim. OAS, OA47	10/-
U4	40 Germanium Transistors like OC81, AC128	10/-
U5	60 200mA Sub-min Sil. Diodes	10/-
U6	40 Silicon Planar Transistors NPN Sim. BSY95A, 2N706	10/-
U7	15 Silicon Rectifiers Top-Hat	10/-
U8	750mA Vltg. Range 0-1000	10/-
U9	50 Silicon Planar Diodes DO-7 Glass 250mA Sim. OA200/202	10/-
U10	20 Mixed Volts 1 Watt Zener Diodes	10/-
U11	20 BAY50 charge storage Diodes DO-7 Glass	10/-
U12	30 PNP Silicon Planar Transistors TO-5 Sim. 2N1132	10/-
U13	12 Silicon Rectifiers Epoxy 500mA up to 800 PIV	10/-
U14	30 PNP-NPN Sil. Transistors OC200 & 2S104	10/-
U15	150 Mixed Silicon and Germanium Diodes	10/-
U16	30 NPN Silicon Planar Transistors TO-5 Sim. BFY50, 2N697	10/-
U17	10 3 Amp Silicon Rectifiers Stud Type up to 1000 PIV	10/-
U18	30 Germanium PNP AF Transistors TO-5 like ACY17-22	10/-
U19	8 6 Amp Silicon Rectifiers BYZ13 Type up to 600 PIV	10/-
U20	12 1.5 Amp Silicon Rectifiers like BC108	10/-
U21	12 1.5 Amp Silicon Rectifiers Top Hat up to 1000 PIV	10/-
U22	30 AF. Germanium Alloy Transistors 2G300 Series & OC71	10/-
U23	10 1 Amp Glass Min. Silicon Rectifiers High Volts	10/-
U24	30 MADD's like MAT Series PNP Transistors	10/-
U25	20 Germanium 1 Amp Rectifiers GJM Series up to 300 PIV	10/-
U26	25 300 Mc/s NPN Silicon Transistors 2N708, BSY27	10/-
U27	26 30 Fast Switching Silicon Diodes like IN914 Micro-Min.	10/-
U28	12 NPN Germanium AF Transistors TO-1 like AC217	10/-
U29	Experimenters Assortment of Integrated Circuits, Untested, Consisting of Gates, Flip-Flops, Buffers, Registers, etc. in Flat-Pack & Dual-in-Line, 8 Assorted Pieces	20/-

Code No.'s mentioned above are given as a guide to the type of device in the Pak. The devices themselves are normally unmarked.

FREE One 10/- Pack of your own choice free with orders valued £4 or over.

TRANSISTOR MANUAL BY G.E. INC.
CIRCUITS, APPLICATIONS, CHARACTERISTICS, L.A.S.C.R.'s, THEORY. G.T. SWITCHES, 30/- EACH THEORY RATINGS, 647 PAGES EACH APPLICATIONS P.P. 2/6
S.C.R. MANUAL BY G.E.

TRANSISTOR EQUIVALENT BOOK
52 pages of Cross References for transistors and diodes, types include British, European, American and Japanese. Specially imported by BI-PAK 10/- each.

OC71 IMPORTANT NOTICE
8/6 EACH OUR ADVERTISED STOCK BY BI-PAK SEMICONDUCTORS

WE HAVE NOT CHANGED OUR NAME OR AMALGAMATED WITH ANY OTHER PAK FIRM. YOU CAN ONLY OBTAIN SENDING TO: C.W.O. please add 1/- p. & p. Min. Order 10/-
500 CHESHAM HOUSE, 150 REGENT STREET, LONDON, W.1.

THE RADIO CONSTRUCTOR

ANNUAL SUBSCRIPTIONS to this magazine

may be obtained direct from the publishers

or through your newsagent

ONLY 42/- per year, post free

Please send remittance with name and address and commencing issue required to:

DATA PUBLICATIONS LTD 57 MAIDA VALE LONDON W9

NEW! PORTABLE SOLID-STATE VOM

A thousand and one uses . . . plus lowest cost
IM-17 Kit £13.12.0 pp.6/-



Solid state circuitry FET input. 4 Silicon transistor, 1 diode. 4 A.C. voltage ranges. 4 d.c. voltage ranges. 4 ohm ranges. 11M ohm input d.c. 1M ohm input on a.c. 4½ in. 200µA meter. Battery powered. Rugged Polypropylene case, self cover and handle. Space for storage of test leads. Easy circuit board construction.

Just right for the householder, hobbyist, boaters, model builders. Amateur radio den and TV service engineer.

LATEST! PORTABLE STEREO RECORD PLAYER, SRP-1

Kit £28.6.0 incl. P.T. p.p. 10/6

Ready-to-Use £35.4.0 incl. P.T. p.p. 10/6



Automatic playing of 16, 33, 45 and 78 rpm records. All transistor—cool instant operation. Dual LP/78 stylus. Plays mono or stereo records. Suitcase portability. Detachable speaker enclosure for best stereo effect. Two 8in x 5in. special loudspeakers. For 220-250V a.c. mains operation. Overall cabinet size 15½ x 3½ x 10½in.

Compact, economical stereo and mono record playing for the whole Family—plays anything from the Beatles to Bartok. All solid-state circuitry gives room filling volume.



ENJOY YOURSELF AND SAVE MONEY HEATHKIT for Britain's Best in Electronic kits

INSTRUMENTS

3" LOW-PRICED SERVICE OSCILLOSCOPE. Model OS-2. Compact size 5" x 7½" x 12" deep. Wt. only 9½lb. "Y" bandwidth 2Hz-3MHz ±3dB. Sensitivity 100mV/cm. T/B 20Hz-200kHz in four ranges, fitted mu-metal CRT Shield. Modern functional styling.

Kit £24.18.0 Ready-to-Use £32.15.0 p.p. 9/-

5" GEN-PURPOSE OSCILLOSCOPE. Model 10-12U. An outstanding model with professional specification and styling. "Y" bandwidth 3Hz-4.5 MHz +3dB. T/B 10 Hz-500 kHz.

Kit £36.18.0 Ready-to-Use £46.16.0 p.p. 10/6

DE LUXE LARGE-SCALE VALVE VOLTMETER. Model IM-13U. Circuit and specification based on the well-known model V-7A but with many worth-while refinements. 6" Ernest Turner meter. Unique gimbal bracket allows operation of instrument in many positions. Modern styling.

Kit £22.8.0 Ready-to-Use £29.10.0 p.p. 7/6

AUDIO SIGNAL GENERATOR. Model AG-9U. 10 Hz to 100 kHz, switch selected. Distortion less than 0.1%, 10V sine wave output metered in volts and dB's.

Kit £28.0.0 Ready-to-Use £36.0.0 p.p. 7/6

VALVE VOLTMETER. Model V-7AU. 7 voltage ranges d.c. volts to 1,500. A.c. to 1,500 r.m.s. and 4,000 peak to peak. Resistance 0.1Ω to 1,000MΩ with internal battery. D.c. input resistance 11MΩ. dB measurement, has centre-zero scale. Complete with test prods, leads and standardising battery. Kit £14.16.0 Ready-to-Use £19.18.0 p.p. 4/6

MULTIMETER. Model MM-1U. Ranges 0-1.5V to 1,500V a.c. and d.c.; 150µA to 15A d.c.; 0.2Ω to 20MΩ. 4½" 50µA meter.

Kit £12.18.0 Ready-to-Use £18.12.0 p.p. 4/6

R.F. SIGNAL GENERATOR Model RF-1U. Up to 100 MHz fundamental and 200 MHz on harmonics. Up to 100mV output.

Kit £13.18.0 Rdy-to-Use £20.8.0 p.p. 6/-

SINE/SQUARE GENERATOR Model 1G-82U. Freq. range 20 Hz-1 MHz in 5 bands less than 0.5% sine wave dist. less than 0.15µ sec. sq. wave rise time.

Kit £25.16.0 Rdy-to-Use £37.16.0 p.p. 10/6

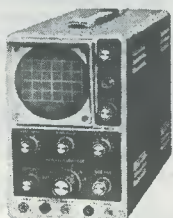

OS-2

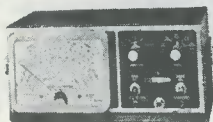

IM-13U



V-7A



RF-1U

Complete your motoring pleasure with this outstanding CAR RADIO, Model CR-1



pp. 4/6 8" x 5"

Will give you superb LW and MW entertainment wherever you drive. Tastefully styled to harmonise with any car colour scheme. Available for your convenience in two separate parts, RF Amp. Kit £11.5.0 incl. P.T. IF/AF Amp. Kit £11.3.6.

Total Price Kit (inc. Loudspeaker) £14.12.0 incl. P.T.

TRANSISTOR RADIOS

OXFORD LUXURY PORTABLE. Model UKR-2. Specially designed for use as a domestic or personal portable receiver. Covers L. and M. Wave bands. 7 transistor, 3 diode, circuit. 7" x 4" loudspeaker for big set sound. Heathkit now offer choice of Brown or Black real leather case. Excellent value at only Kit £15.10.0 inc. P.T. p.p. 6/-



UKR-2

TRANSISTOR PORTABLE, Model UKR-1. Now available in modern colours or real leather case. 6 Transistor, 1 diode circuit for reliability. Pre-aligned I.F. transformers. Covers L.W. and M. Wave bands. 7" x 4" loudspeaker for generous sound. Case available in colours Navy Blue, Coral Pink, Lime Green or Brown Real Leather. Please state second choice. Kit £12.8.0 Colour incl. P.T. p.p. 4/6.

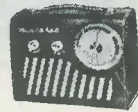

UKR-1

Kit £13.8.0 Real leather incl. P.T. p.p. 4/6.

STEREO TRANSISTOR FM TUNER

(Mono version also available)

14 transistor, 5 diode circuit. Tuning range 88-108 MHz. Designed to match the AA-22U Amplifier. Available in separate units, can be built for a total price.



TFM-IS Kit (Stereo) £27.10.0 incl. P.T. p.p. 6/-

Cabinet extra £4.0.0.

FM Tuner

VISIT THE HEATHKIT CENTRES

GLOUCESTER Bristol Road Tel. 29451

LONDON 233 Tottenham Ct. Rd. Tel. 01-636 7349

BIRMINGHAM 17-18 St. Martin Hse, Bull Ring Tel. 021-643 4386

SEE HOW EASY-IT-IS TO BUILD ANY HEATHKIT MODEL YOURSELF

Full details of manual only purchase scheme in latest catalogue. Remember all Heathkit models are fully guaranteed.

LATEST! STEREO AMPLIFIER, TSA-12

12 x 12 watts output.

Kit **£32.16.0** less cabinet p.p. 10/6

Cabinet **£3.16.0** extra

Ready-to-Use **£39.10.0** less cabinet p.p. 10/6

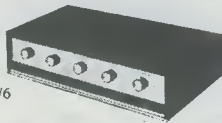

FOR THIS SPECIFICATION

● 17 transistors, 6 diode circuit ● ± 1 dB, 16 to 50,000 Hz at 12 watts per channel into 8 ohms ● Output suitable for 8 or 15 ohm loudspeakers ● 3 stereo inputs for Gram, Radio and Aux. ● Modern low silhouette styling ● Attractive aluminium, golden anodised front panel ● Handsome assembled and finished walnut veneered cabinet available ● Matches Heathkit models TFM-1 and AFM-2 transistor tuners.

Full range power . . . over extremely wide frequency range. Special transformerless output circuitry. Adequately heat-sinked power transistors for cool operation—long life. 6 position source switch.

FULL SPECIFICATION SHEET AVAILABLE

LATEST! STEREO TAPE RECORDER, STR-1

Fully portable—own speakers

Kit **£58.0.0** incl. P.T. p.p. 10/6

Ready-to-Use **£72.0.0** incl. P.T. p.p. 10/6

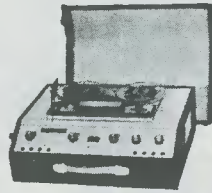

FOR THIS SPECIFICATION

● $\frac{1}{4}$ track stereo or mono record and playback at 7 $\frac{1}{2}$, 3 $\frac{1}{2}$ and 1 $\frac{1}{2}$ ips ● Sound-on-sound and sound-with-sound capabilities ● Stereo record, stereo playback, mono record and playback on either channel ● 18 transistor circuit for cool, instant and dependable operation ● Moving coil record level indicator ● Digital counter with thumbwheel zero reset ● Stereo microphone and auxiliary inputs and controls, speaker/headphone and external amplifier outputs . . . front panel mounted for easy access ● Push-button controls for operational modes ● Built-in stereo power amplifier giving 4 watts rms per channel ● Two high efficiency 8" x 5" speakers ● Operates on 230V a.c. supply.

Versatile recording facilities. So easy to build—so easy to use.

FULL SPECIFICATION SHEET AVAILABLE

WORLD LEADER IN QUALITY KITSETS

The instruction manual shows you how to build the model.



SHORTWAVE 4 BAND RECEIVER, GR-64E

Offers you the exciting world of Shortwave

Covers 550 kHz to 30 MHz incl. broadcast plus 3 SW bands. 4 valve superhet circuit plus 2 silicon rectifiers. Own 5" speaker. Illuminated 7" slide-rule dial with logging scale. Signal strength indicator.

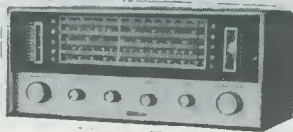

Variable BFO control. Built in AM rod antenna. Circuit Board construction. Headphone jack. Attractive charcoal grey cabinet with black dial panel with green/white markings. Assemble in a few hours. Hear live broadcasts from around the Globe.

Kit **£22.8.0** pp 9/- Ready to use **£29.8.0** pp 9/-

"AMATEUR" EQUIPMENT

THE "MOHICAN" GENERAL COVERAGE RECEIVER. Model GC-1U. With 4 piezo-electric transmitters, variable tuned B.F.O. and Zener diode stabiliser, this is an excellent fully transistorised general purpose receiver for Amateur and Short wave listeners. Printed circuits, telescopic aerial, tuning meter and large slide-rule dial. Kit **£38.8.0** Ready-to-Use **£46.8.0** p.p. 10/6

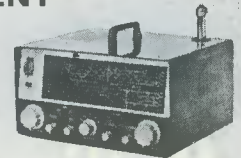

GC-1U

AMATEUR BANDS RECEIVER. Model RA-1. To cover all the Amateur Bands from 160-10 metres. Many special features, including: high-lattice crystal filter; 8 valves; signal strength "S" meter; tuned R.F. Amp. stage. Kit **£39.16.0** Ready-to-Use **£53.0.0** p.p. 9/-



RA-1

160-10M TRANSMITTER. Model DX-100U. Careful design has achieved high performance and stability. Completely self-contained. Kit **£95.0.0** Ready-to-Use **£120.0.0** p.p. 19/6

COMMUNICATIONS TYPE RECEIVER. Model RG-1. A high performance, low cost receiver for the discriminating listener. Frequency coverage: 600 kHz 1.5 MHz and 1.7 MHz-32 MHz.

Kit **£39.16.0** Ready-to-Use **£53.0.0** pp. 9/-

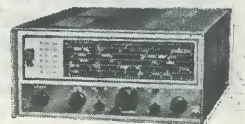

RG-1



SSU-1

SPEAKER SYSTEMS

HI-FI SPEAKER SYSTEM, Model SSU-1

Ducted-port bass reflex cabinet in the white: Two speakers, vertical or horizontal models with legs, **KIT £13.4.0.** p.p. 7/6 without legs.

Set of 4 legs 7" or 15" (Please state length required) 16/-, pp. 4/6.

AVON MINI SPEAKER SYSTEM

6 $\frac{1}{2}$ " Bass, 3 $\frac{1}{2}$ " Treble speakers and crossover unit. Kit **£6.0.0.** incl. P.T. Beautiful Walnut veneered fully-finished cabinet, **£9.8.0** Total price Kit **£15.0.0** incl. P.T. p.p. 10/6

Ready to use **£20.14.0** pp. 10/6

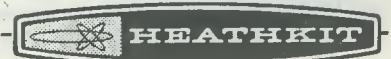

FREE! CATALOGUE

Describes these and many more kits and ready-to-use models for Stereo/Hi-Fi, Domestic Radio, Record Players, Tape Recorder, Amateur Radio, Shortwave, Test, Educational, Home and Hobby. Save money with Heathkit models. Mail coupon or write to Daystrom Ltd., Gloucester. Tel: 29451.

DAYSTROM LTD., Dept. RC-10
GLOUCESTER Tel. 29451

Enclosed is £ _____, plus packing and carriage.

Please send model (s) _____

Please send FREE Heathkit Catalogue.

Name _____

(Please Print)

Address _____

City _____

Prices and specifications subject to change without notice.

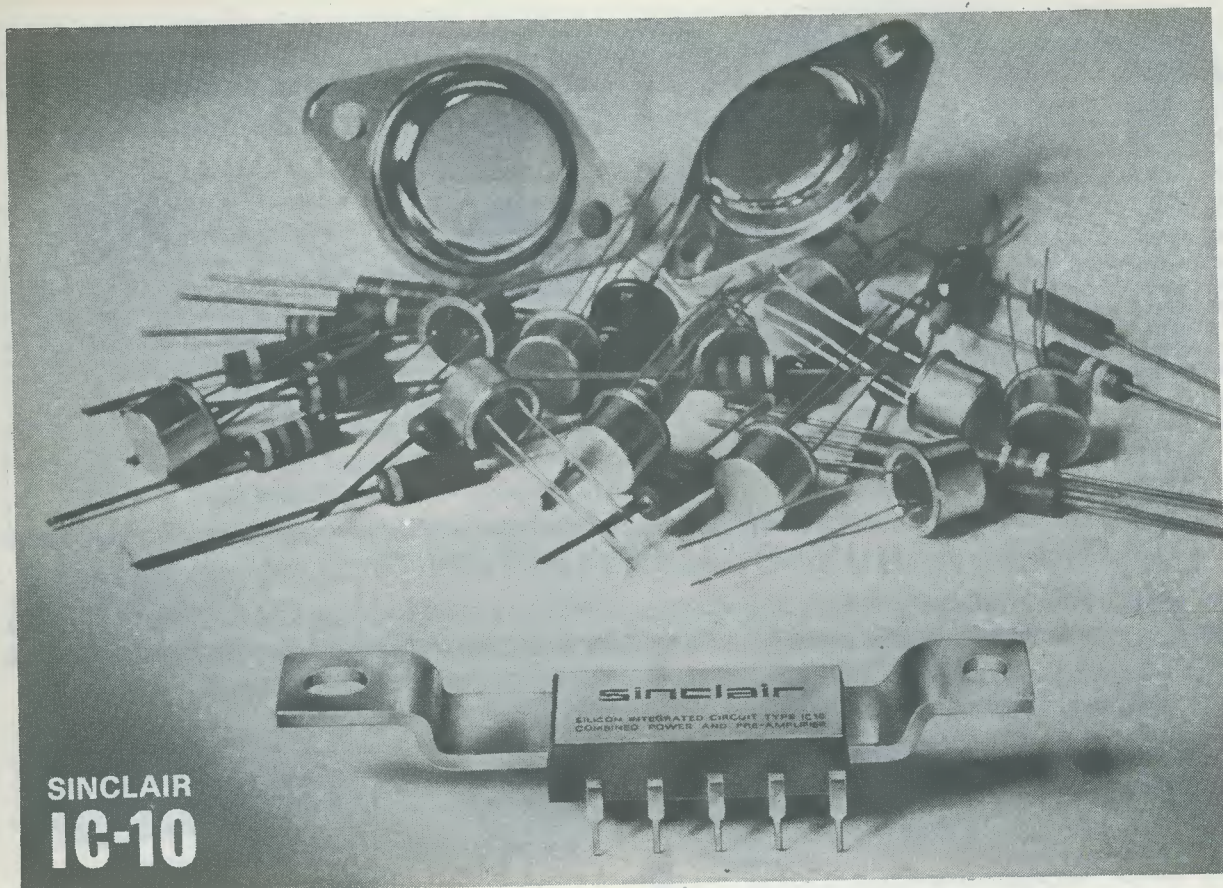

**SINCLAIR
IC-10**

the world's most advanced high-fidelity amplifier

The Sinclair IC-10 is the World's first monolithic integrated circuit high fidelity power amplifier and pre-amplifier. The circuit itself, which has an output power of 10 Watts, is a chip of silicon only a twentieth of an inch square by one hundredth of an inch thick. This tiny chip contains 13 transistors (including two power types), 2 diodes, 1 zener diode and 18 resistors, all of which are formed simultaneously in the silicon by a series of diffusions. The chip is encapsulated in a solid plastic package which holds the metal heat sink and connecting pins.

Monolithic I.C.'s. were originally developed for use in computer and space applications where their extraordinary toughness and reliability were even more important than their minute size. These same advantages make them ideal for linear applications such as audio amplifiers, but hitherto they have been confined to low power applications. The IC-10 thus represents a very exciting advance. Not only is it far more rugged and reliable than any previous amplifier, it also has considerable performance advantages. The most

important are complete freedom from thermal runaway due to the close thermal coupling between the output transistors and the bias diodes and very low level of distortion.

The IC-10 is primarily intended as a full performance high fidelity power and pre-amplifier, for which application it only requires the addition of the usual tone and volume controls and a battery or mains power supply. However, the IC-10 is so designed that it may be used simply in many other applications including car radios, electronic organs, servo amplifiers (it is d.c. coupled throughout) etc.

The photographic masks required for producing monolithic I.C.'s. are expensive but once made, the circuits can be produced with complete uniformity and at very low cost. So we are able to sell the IC-10 at a price far below that of the components for a conventional amplifier of comparable power. At the same time, we give a 5 year unconditional guarantee on each IC-10 knowing that every unit will work as perfectly as the original and do so for a lifetime.

sinclair

SINCLAIR RADIONICS LTD, 22 Newmarket Rd. Cambridge. Tel: OCA3-52996

10 WATT MONOLITHIC INTEGRATED CIRCUIT AMPLIFIER

■ Specifications

Power Output 10 Watts peak, 5 Watts R.M.S. continuous
 Frequency response 5 Hz to 100 KHz ± 1 dB
 Total harmonic distortion Less than 1% at full output
 Load impedance 3 to 15 ohms
 Power gain 110dB (100,000,000,000 times) total
 Supply voltage 8 to 18 volts
 Size 1 x 0.4 x 0.2 inches
 Sensitivity 5 mV
 Input impedance Adjustable externally up to 2.5 M ohms for above sensitivity

■ Circuit Description

The circuit diagram of the 1C-10 is shown on the right. The first three transistors are used in the pre-amp and the remaining 10 in the power amplifier. The output stage operates in class AB with closely controlled quiescent current which is independent of temperature. A high level of overall negative feedback is used round both sections and the amplifier is completely free from cross-over distortion at all supply voltages. Thus battery operation is eminently satisfactory.

■ Construction

The monolithic I.C. chip is bonded onto a gold plated area on the heat sink bar which runs through the package. Wires are then welded between the I.C. and the tops of the pins which are also gold plated in this region. Finally the complete assembly is encapsulated in solid plastic which completely protects the circuit. The final device is so rugged that it can be dropped thirty feet on to concrete without any effect on performance. The circuit will also work perfectly at all temperatures from well below zero to above the boiling point of water.

■ Other Sinclair Products

Micromatic—the world's smallest personal radio. Kit, complete 49/6: Built and tested 59/6. Q.14 low priced hi-fi speaker, 8 ohms/14 watts loading £7 19s. 6d. PZ.4 stabilised power pack, giving 18 V.d.c. at 1.5A, 99/6.

SINCLAIR GUARANTEE

Should you not be completely satisfied with your purchase when you receive it from us, your money will be refunded in full at once and without question. Full service facilities available to all purchasers.

SINCLAIR RADIONICS LIMITED

22 NEWMARKET ROAD, CAMBRIDGE

Telephone 0CA3-52731

OCTOBER 1968

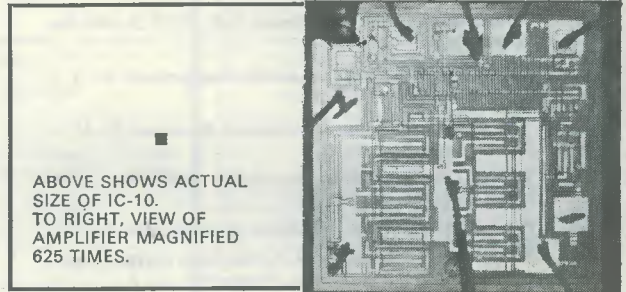

ABOVE SHOWS ACTUAL SIZE OF IC-10. TO RIGHT, VIEW OF AMPLIFIER MAGNIFIED 625 TIMES.

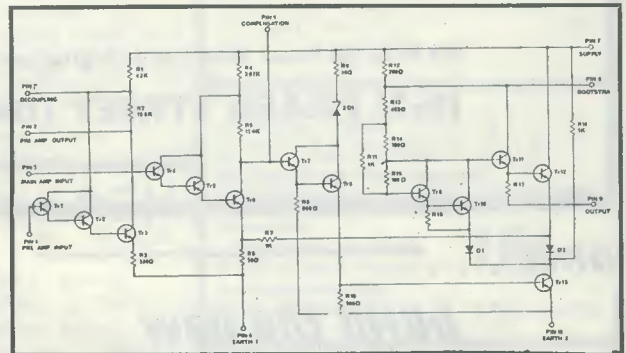

■ Applications

Each 1C-10 is sold with a very comprehensive manual giving circuit and wiring diagrams for a large number of applications in addition to high fidelity uses. These include public address, loud-hailers, use in cars, inter-com, stabilised power supplies, electronic organs, oscillators, volt meters, tape recorders, solar cell amplifier, radio receivers.

The transistors in the 1C-10 have cut off frequencies greater than 500 MHz so the pre-amp section can be used as an R.F. or I.F. amplifier making it possible to build complete radio receivers without any additional transistors.

SINCLAIR 1C-10

The complete IC-10 with the manual and 5 year guarantee costs just

59%

Post free

To: SINCLAIR RADIONICS LIMITED, 22 NEWMARKET ROAD, CAMBRIDGE.

Please send POST FREE

NAME

ADDRESS

For which I enclose cash/cheque/money order.

RC.1068

THE MODERN BOOK CO

Amateur Radio Techniques. Pub. R.S.G.B. **12s. 6d.** Postage 9d.

Radio & Electronic Handbook. By G. R. Wilding. **17s. 6d.** Postage 1s.

Colour Television. Pal System. By G. N. Patchett. **40s.** Postage 1s.

Amateur Radio Circuit Book. Pub. R.S.G.B. **10s. 6d.** Postage 9d.

Rapid Servicing of Transistor Equipment. By G. J. King. **30s.** Postage 1s. 6d.

Introduction to Semiconductor Devices. By M. J. Morant. **18s.** Postage 1s.

The All-In-One Tape Recorder Book. By J. M. Lloyd. **15s. 6d.** Postage 9d.

Fun with Tape. By J. G. Staab. **21s.** Postage 9d.

Television Explained. Vol. 1. Television Fundamentals. By E. A. W. Spreadbury. **25s.** Postage 1s.

Television Explained. Vol. 2. Pal Colour System. By E. A. W. Spreadbury. **18s. 6d.** Postage 1s.

Inter: GEC Transistor Manual. 7th edition. **21s.** Postage 2s.

Designer's Guide to British Transistors. By I. J. Kampel. **25s.** Postage 1s.

Mullard Data Book 1968. **3s. 6d.** Postage 6d.

RCA Transistor Manual. **30s.** Postage 1s. 6d.

Radio Valve Data. Compiled "WW". 8th edition. **9s. 6d.** Postage 1s.

Beginner's Guide to Transistors. By J. A. Reddihough. **15s.** Postage 1s.

Transistors for Technical Colleges. By L. Barnes. **25s.** Postage 1s.

Everyday Electronics By T. Roddam. **22s 6d.** Postage 1s

Transistor Pocket Book. By R. G. Hibberd. **25s.** Postage 1s.

Radio and Audio Servicing Handbook. By G. J. King. **30s.** Postage 1s. 6d.

We have the Finest Selection of English and American Radio Books in the Country

19-21 PRAED STREET (Dept RC) LONDON W2

Telephone PADdington 4185

now . . .

build the new
RM 'SINGLET'
SUPERHET RECEIVER
for RADIO CONTROL!

TWO-PART

*** CONSTRUCTIONAL**

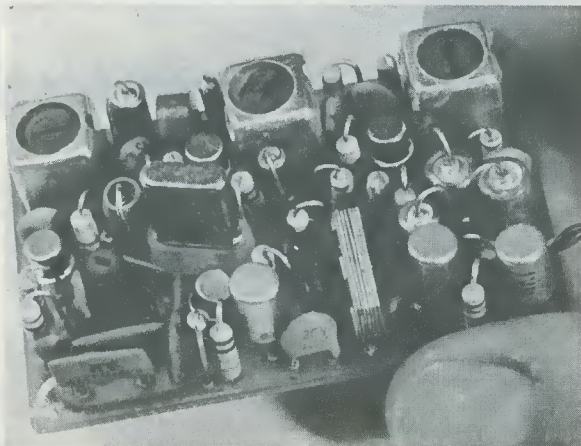

FEATURE in the October and November issues of "RADIO MODELLER"

3/6 at your Newsagents — book your copies now!

OR order direct and avoid disappointment—we pay post!

Send 7/— P.O. to: "RADIO MODELLER" (Dept. SH),
64 WELLINGTON ROAD, HAMPTON HILL, MIDDLESEX

BI-PRE-PAK LIMITED

TRANSISTORS PRICE

AC107	3/-	OC170	3/-
AC126	2/4	OC171	4/-
AC127	2/4	OC200	3/6
AC128	2/4	OC201	2/6
AC117	3/-	2G301	7/6
AF114	4/-	2G303	2/6
AF115	3/6	2N711	10/-
AF116	3/6	2N1302-3	4/-
AF117	3/6	2N1304-5	5/-
AF118	3/6	2N1306-7	6/-
AF119	3/6	2N1308-9	8/-
AF186	10/-	2N3844A	5/-
AF139	10/-		
BFY50	4/-	Power Transistors	
BSY25	7/6	OC20	10/-
BSY26	3/-	OC23	10/-
BSY27	3/-	OC25	8/-
BSY28	3/-	OC26	5/-
BSY29	3/-	OC28	7/6
BSY95A	3/-	OC35	5/-
OC41	2/6	OC36	7/6
OC44	1/11	AD149	10/-
OC45	1/9	2N2287	20/-
OC71	2/6	Diodes	
OC72	2/6	AA42	2/-
OC73	3/6	OA95	2/-
OC81	2/6	OA70	1/9
OC81D	2/6	OA79	1/9
OC83	4/-	OA81	1/9
OC139	2/6	OA73	2/-
OC140	3/6	IN914	1/6

EXCITING NEW PAKS

FOR AMATEURS, PROFESSIONALS, FACTORIES, ORGAN BUILDERS, AND THOSE PEOPLE THAT JUST USE LARGE QUANTITIES OF TRANSISTORS.

XA PAK

Germanium PNP type transistors, equivalents to a large part of the OC range, i.e. 44, 45, 71, 72, 81, etc.

PRICE £5 PER 1000

XB PAK

Silicon TO-18 CAN type transistors NPN/PNP mixed lots, with equivalents to OC200-1, 2N706A, BSY27/29, BSY95A.

PRICE £5.50 PER 500

PRICE £10 PER 1000

XC PAK

Silicon diodes miniature glass types, finished black with polarity marked, equivalents to OA200, OA202, BAY31-39 and DK10, etc.

PRICE £5 PER 1000

ALL THE ABOVE UNTESTED PAKS HAVE AN AVERAGE OF 75% OR MORE GOOD SEMICONDUCTORS. FREE PAKS SUSPENDED WITH THESE ORDERS. ORDERS MUST NOT BE LESS THAN THE MINIMUM AMOUNTS QUOTED PER PAK.

P/P 2/6 PER PAK (U.K.)

PRE-PAKS

Selection from our lists

No.	Description	Price
B1	50 Unmarked Trans. Untested	10/-
B2	4 Photo Cells Inc. Book of Instructions	10/-
B6	17 Red Spot AF Transistors	10/-
B6A	17 White Spot RF Transistors	10/-
B9	1 ORP 12 Light Sensitive Cell	9/-
B53	25 Sil. Trans. 400 Mc/s	Brand New 10/-
B54	40 " " NPN to 5	Trans Voltage 10/-
B55	40 " " NPN to 18	& Gain Fallouts 10/-
B56	40 " " NPN/PNP	All Tested 10/-
B68	10 Top Hat Recs. 750 M/A 100-800 PIV	10/-
B69	20 Diodes. Gld.-Bnd. Germ Sil. Planer	10/-
B74	5 Gld.-Bnd. Diodes. 2-OA9, 3-OA5	10/-
B75	3 Comp. Set. 2G371, 2G381, 2G339A	10/-
C2	1 Unijunction Transistor 2N2160	15/-
C32	6 Top Hat Recs. IS100 Type	15/-
C35	3 Unijunction Trans. T02N2160	15/-
A1	7 Silicon Rectifiers BY100 Type	20/-
A3	25 Mixed Marked and Tested Transistors	20/-
A21	5 Power Transistors 1-AD149/1-OC26 and 3 others	20/-

AND MANY MORE

FREE!

PACKS OF YOUR OWN CHOICE UP TO THE VALUE OF 10/- WITH ORDERS OVER £4

TRANSISTORS ONLY 1/- EACH

SILICON • PLANAR • N.P.N. • P.N.P.

All these types available

2N929 2N706 2S131 2S103 2N696 2N1613 2S733 BFY10
2S501 2N706A 2S512 2S104 2N697 2N1711 2N726 2S731
BC108 2N3011 2S102 2N2220 2N1507 2N1893 2N2484 2S732

All tested and guaranteed transistors—unmarked. Manufacturers over runs for the new PRE-PAK range.

BRAND NEW PAK !!! JUST RELEASED !!!

REPLACES OUR VERY POPULAR B39 PAK Short Lead Components, all Brand New and Factory Marked, mounted on Printed Circuit Panels.

Approximately:

80 TRANSISTORS AND DIODES
50 HIGH TOLERANCE RESISTORS
20 VARIOUS CAPACITORS

10/-

Please state when ordering Pak. P.1. 2/6 Post and Packing with this pack.

Make a Rev. Counter for your Car. The 'TACHO BLOCK'. This encapsulated block will turn any 0-1mA meter into a perfectly linear and accurate rev. counter for any car. State 4 or 6 cylinder.

20/- each

FREE CATALOGUE AND LISTS for:—

ZENER DIODES
TRANSISTORS, RECTIFIERS
FULL PRE-PAK LISTS
& SUBSTITUTION CHART

MINIMUM ORDER 10/- CASH WITH ORDER PLEASE. Add 1/- post and packing per order. OVERSEAS ADD EXTRA FOR AIRMAIL.

THERE IS ONLY ONE
BI-PRE-PAK LTD
BEWARE OF IMITATIONS

NEW UNMARKED UNTESTED PAKS

25	BSY95A NPN Silicon	TRANSISTORS 10/-
10	1000 PIV 1 amp. Min. Silicon	DIODES 10/-
25	BSY26-27 NPN Silicon	TRANSISTORS 10/-
10	10 Watt Silicon All Voltages	ZENERS 10/-
25	BFY50-1-2 NPN Silicon	TRANSISTORS 10/-
10	4 amp. Stud. Silicon	RECTIFIERS 10/-
25	BC107-8-9 NPN Silicon	TRANSISTORS 10/-
40	1N914-6 OA200/202 Sub. Min. Silicon	DIODES 10/-
150	Min. Germ. High Quality	DIODES 10/-
25	2N706 A NPN Silicon	TRANSISTORS 10/-

PRE-PAK. N.605 POWER TRANSISTOR EQUIVALENT TO NKT301

5/- each

COMPLEMENTARY SET NPN/PNP GERM. TRANS.

pair 2/6

FIRST EVER LOGIC KITS

Learn for yourself how computers work, even make one for yourself. Full instructions for a noughts and crosses machine, binary counters, timers, etc. L1. 5gns. L2. 10gns. Introducing the Norkit range. Norkit Junior £8. Norkit Senior £16.

Details Free
Free Paks suspended with Logic Kit Orders.

FREE! A WRITTEN GUARANTEE WITH ALL OUR SEMICONDUCTORS

BI-PRE-PAK LTD DEPT. A, 222-224 WEST ROAD, WESTCLIFF-ON-SEA, ESSEX
TELEPHONE: SOUTHEND (0702) 46344

Ordering Components is FUN



with THIS Catalogue in your hands!

**A bargain
at 7'6
plus 3'-p&p.**

Ever had trouble locating a particular piece for your project? Ever wasted time thumbing through confusing price lists? Ever been foot-weary and frustrated tramping round the shops?

Sigh no more. Just sink into an armchair and enjoy life with a Home Radio Catalogue! Pick your parts. Grab your pen. Make for a letter-box. Your chosen items will be with you almost before you can get back to that armchair!

This Catalogue really is a *must* if you're interested in Radio and Electronics. It has 256 pages, over 7,000 items listed, over 1,300 illustrations. With each catalogue we supply a Bargain List, a Book Mark giving Electronic Abbreviations, an Order Form and an Addressed Envelope. All this for only 7/6 plus 3/- post and packing. By the way, every catalogue contains 5 vouchers, each worth 1/- when used as directed. Send the coupon today with your cheque or P.O. for 10/6.

*Please write your Name and Address in block capitals
United Kingdom addresses only*

NAME.....

ADDRESS.....

.....

.....

Home Radio (Mitcham) Ltd., Dept. RC, 187 London Rd.,
Mitcham CR4 2YQ

VERSATILE TRANSFORMERLESS

by W. KEMP

This neat general-purpose amplifier is assembled without crowding of components, on a Veroboard panel measuring less than 4 by 1½ inches. A particularly attractive feature of the design is that the circuit can accommodate a very wide range of alternative transistor types without any changes in component values.

A MAJOR DISADVANTAGE WITH THE OLDER TYPES OF transistor amplifiers, which used transformer coupling between stages, was that the transformers almost invariably caused distortion and gave a non-linear frequency response due to their very small size and consequent loss of efficiency. In addition, these transformers added appreciably to the total cost of the amplifiers. Fortunately, it is possible, using current design techniques, to completely eliminate the transformer from the power amplifier circuitry, and thereby improve the frequency response, reduce distortion, and lower building costs. The amplifier that forms the basis of this article employs these design techniques.

Amongst the unusual design features of this particular amplifier are (a) the use of bootstrapping techniques to give the maximum possible power gain, (b) the generous use of a.c. negative feedback to minimise distortion and give a wide frequency response, and (c) the use of twin d.c. negative feedback loops to give a high order of temperature stabilisation and to permit the use of a wide range of transistor types.

This last point is of particular importance; many readers have spare transistors available, for which no useful circuits have so far been published, and these transistors are consequently wasted. The design of this particular amplifier is such, however, that almost any

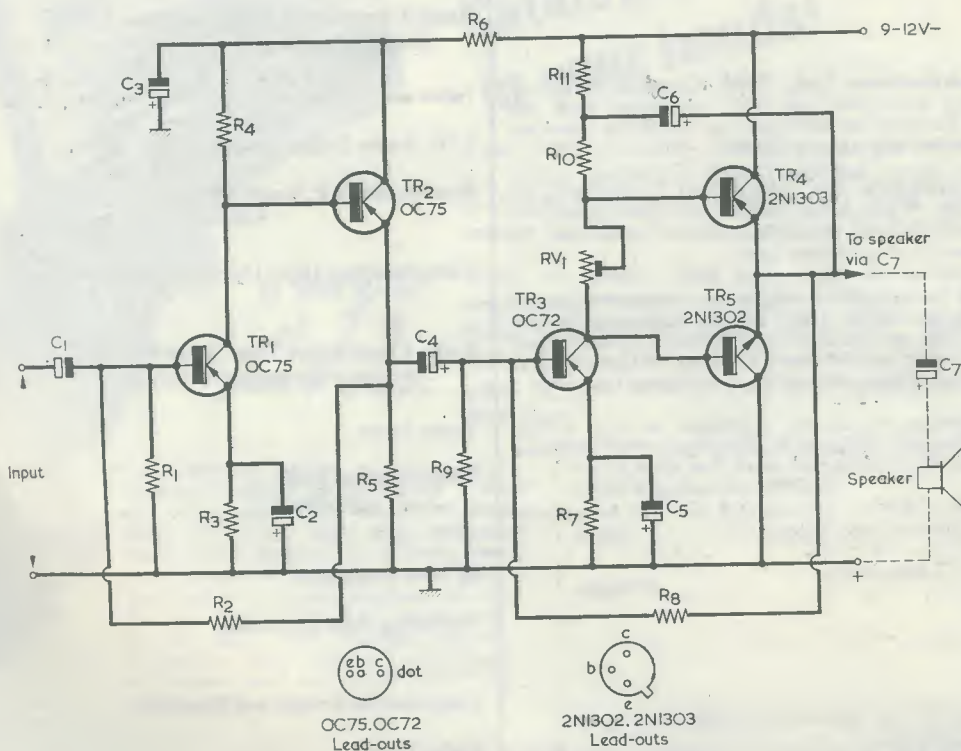

Fig. 1. The full circuit of the 300mW transformerless amplifier.

300mW AMPLIFIER

germanium transistors may be used, providing that they are either p.n.p. or n.p.n. types as stipulated and meet power dissipation requirements, without any need for alteration in component values.

As may be seen from the circuit diagram given in Fig. 1, there are five transistors. TR₁ and TR₂ are shown as OC75 but they may be any other small germanium p.n.p. transistor, and a list of suitable alternatives is given in the Components List. TR₃ is a driver and any germanium transistor with a maximum collector current rating of 20mA or more may be used. TR₄ and TR₅ are medium power

COMPONENTS

Resistors

(All fixed values $\frac{1}{4}$ watt 10%)

R ₁	8.2k Ω
R ₂	47k
R ₃	1k Ω
R ₄	8.2k Ω
R ₅	5.6k Ω
R ₆	1k Ω
R ₇	100 Ω
R ₈	12k Ω
R ₉	2.2k Ω
R ₁₀	470 Ω
R ₁₁	180 Ω
RV ₁	100 Ω miniature skeleton preset

Capacitors

(All capacitors are sub-miniature electrolytic)

C ₁	16 μ F, 15V wkg.
C ₂	30 μ F, 6V wkg.
C ₃	50 μ F, 15V wkg.
C ₄	50 μ F, 12V wkg.
C ₅	30 μ F, 6V wkg.
C ₆	160 μ F, 12V wkg.
C ₇	200 to 1,000 μ F (see text), 12V wkg.

Transistors

TR ₁ , TR ₂	OC75 (or OC71, 2G371, 2G381, 2G382, etc.)
TR ₃	OC72 (or OC81, 2G371, 2G381, 2G382, etc.)
TR ₄	2N1303 (or OC81, 2G382, 2N1305, 2N1307, 2N1309, etc.)
TR ₅	2N1302 (or 2N1304, 2N1306, 2N1308, etc.)

Miscellaneous

- 9 or 12 volt battery
- Speaker (see text)
- Veroboard panel, 0.15 in matrix, $1\frac{3}{8}$ x $3\frac{5}{8}$ in (see Fig. 3)
- Screened wire, sleeving, etc.

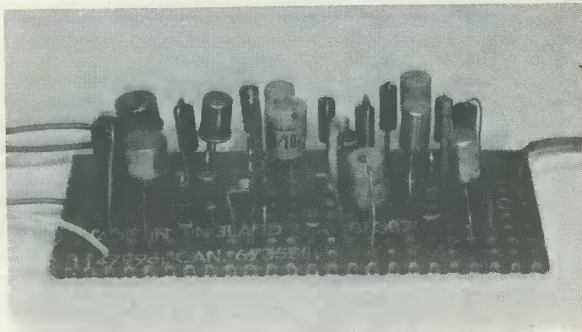

Side view of the amplifier. The input screened cable is to the right.

types and should have a maximum collector current rating of 300mA or more. Again, alternatives are listed in the Components List. Note that TR₃ and TR₄ are p.n.p., and that TR₅ is n.p.n.

With a 12 volt supply, about 300mW output will be given into a 15 Ω speaker. The speaker impedance may be 25 Ω to 15 Ω , but should not be lower than 15 Ω with transistors having a maximum collector current rating of 300mA.

The input impedance of the amplifier is of the order of 500 Ω and requires an input of approximately 20mV for maximum output. It is designed primarily for use with a tuner unit. For low level inputs, such as are given by a microphone, it will be necessary to add a one-stage or two-stage preamplifier.

THE CIRCUIT

In Fig. 1, the input signal is fed via C₁ to the base of TR₁, which is wired as a fairly conventional common emitter amplifier with collector load R₄ and emitter bias resistor R₃, bypassed by C₂.

In conventional practice the output from TR₁ collector would be fed via a blocking capacitor directly to the base of TR₃, the output driver transistor, but it would then be found that the low input impedance of TR₃, which may be of the order of a few hundred ohms, would be effectively in parallel with R₄ and TR₁ would give a very low voltage (and thus power) gain. In Fig. 1 this difficulty is overcome by interposing an emitter follower, TR₂, between TR₁ collector and the following stages.

The emitter follower offers high input and low output impedance, and gives unity voltage gain, the output at the emitter being in phase with the input signal at the base. It is interesting to note that, although the emitter follower itself gives no useful voltage gain, its use does cause the voltage gain of the TR₁ - TR₂ combination to be increased by some 20 or more times. Without TR₂, the effective value of TR₁ collector load could be that many times lower than the effective value given with TR₂ in circuit.

The base bias to TR₁ is provided via R₁ and R₂, and it should be noted that R₂ is coupled directly to TR₂ emitter; a negative feedback loop is thus formed. This feedback loop uses both d.c. and a.c. coupling, so that the circuit is well stabilised against changes in temperature and transistor characteristics. The feedback also causes distortion and noise to be reduced, and frequency response to be improved.

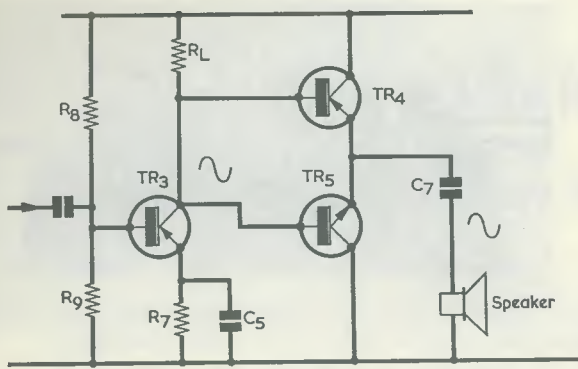

(a)

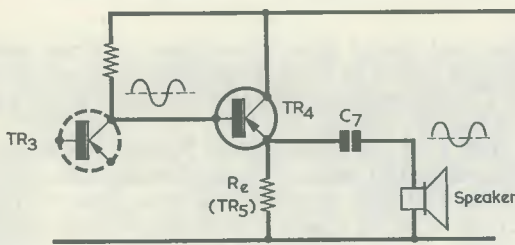

(b)

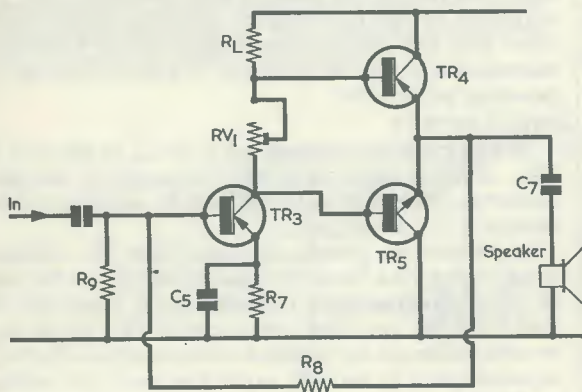

(c)

Fig. 2(a). A simplified circuit representing the driver and output stages.

(b). Showing emitter follower operation in TR₄.

(c). An improved version of (a) which offers stabilising and reduces crossover distortion.

The signal is next taken from the emitter of TR₂ and fed via C₄ to the base of TR₃, the driver transistor, and thence on to the two output transistors, TR₄ and TR₅.

The operation of the section incorporating TR₃, TR₄ and TR₅ is a little complex, and can best be understood by following its development from basic principles. This circuit is shown in its most basic form in Fig. 2(a), and here it can be seen that TR₃ is wired as a conventional common emitter amplifier, with base bias resistors R₈ and R₉, emitter bias resistor R₇, and collector load R_L.

The collector of TR₃ is direct coupled to the base of p.n.p. transistor TR₄ and to the base of n.p.n. transistor TR₅; these two transistors have their emitters directly coupled to one another, and are in fact each wired as emitter followers. This emitter follower connection is made clear in Fig. 2(b), which shows that TR₄ uses TR₅ as its emitter load, R_e, at d.c., and adds C₇ and the speaker to the emitter load at a.c. Similarly, the n.p.n. transistor, TR₅, is wired as an emitter follower with TR₄ as its d.c. emitter load, with C₇ and the speaker added as its a.c. emitter load. Thus, C₇ and the speaker form an a.c. load common to both transistors.

Now, one of the shortcomings of the conventional emitter follower if used on its own in an output stage is that considerable distortion can occur if the a.c. load is appreciably lower than the d.c. emitter load, and this point is made clear with reference to Fig. 2b. Here, if the signal voltage on the base of TR₄ moves in a negative direction the emitter current will increase, a small part of this current being supplied from the positive line via R_e, and the major part being supplied from the positive line via the speaker and C₇. Since the impedance at the emitter of the transistor is low, a relatively high signal current flows and the voltage at C₇ will follow the input signal closely. When the input moves in a positive direction, however, the current in C₇ and the speaker has to flow in R_e. If this offers a considerably greater impedance than did TR₄ with the negative-going signal, the signal current in C₇ and the speaker is much lower. The consequent distortion is shown in the diagram.

A similar action takes place if an n.p.n. emitter follower is used on its own, but in this case the output will "follow" the positive swings and distort the negative ones, this being the direct opposite of the results given with the p.n.p. transistor.

Returning to Fig. 2(a) we see that we have two emitter followers, whereupon the difficulties just described do not apply. When TR₃ collector goes negative the output across the speaker "follows" the signal via the low impedance in TR₄. When TR₃ collector goes positive the output across the speaker then "follows" the signal via the low impedance in TR₅. The two emitter followers TR₄ and TR₅ are therefore complementary to each other. It should be added that these two transistors do *not* need to be matched for gain.

With the circuit shown in Fig. 2(a) two further points have to be considered. The first of these is that, since TR₄ and TR₅ bases are direct coupled, these transistors will be cut off when no input signal is applied, and crossover distortion will result. The second is that, if the maximum undistorted output is to be made available, the output should be held at a mean (d.c.) level of approximately half the supply rail voltage. Using the simple biasing arrangements shown in Fig. 2(a), this voltage can be subject to considerable variation with changes in temperature and in transistor characteristics.

Both of these troubles are overcome in Fig. 2(c). Variable resistor RV₁ is used to apply a small amount of base bias to TR₄ and TR₅, so that both transistors are conducting when no input signal is applied. Crossover distortion is thus minimised. The base bias to TR₃ is derived from the emitters of TR₄ and TR₅ via R₈, so that a negative feedback loop is formed, thus stabilising the mean voltage levels in the circuit. This negative feedback loop is effective with both a.c. and d.c., so that distortion is also minimised and the frequency response is improved.

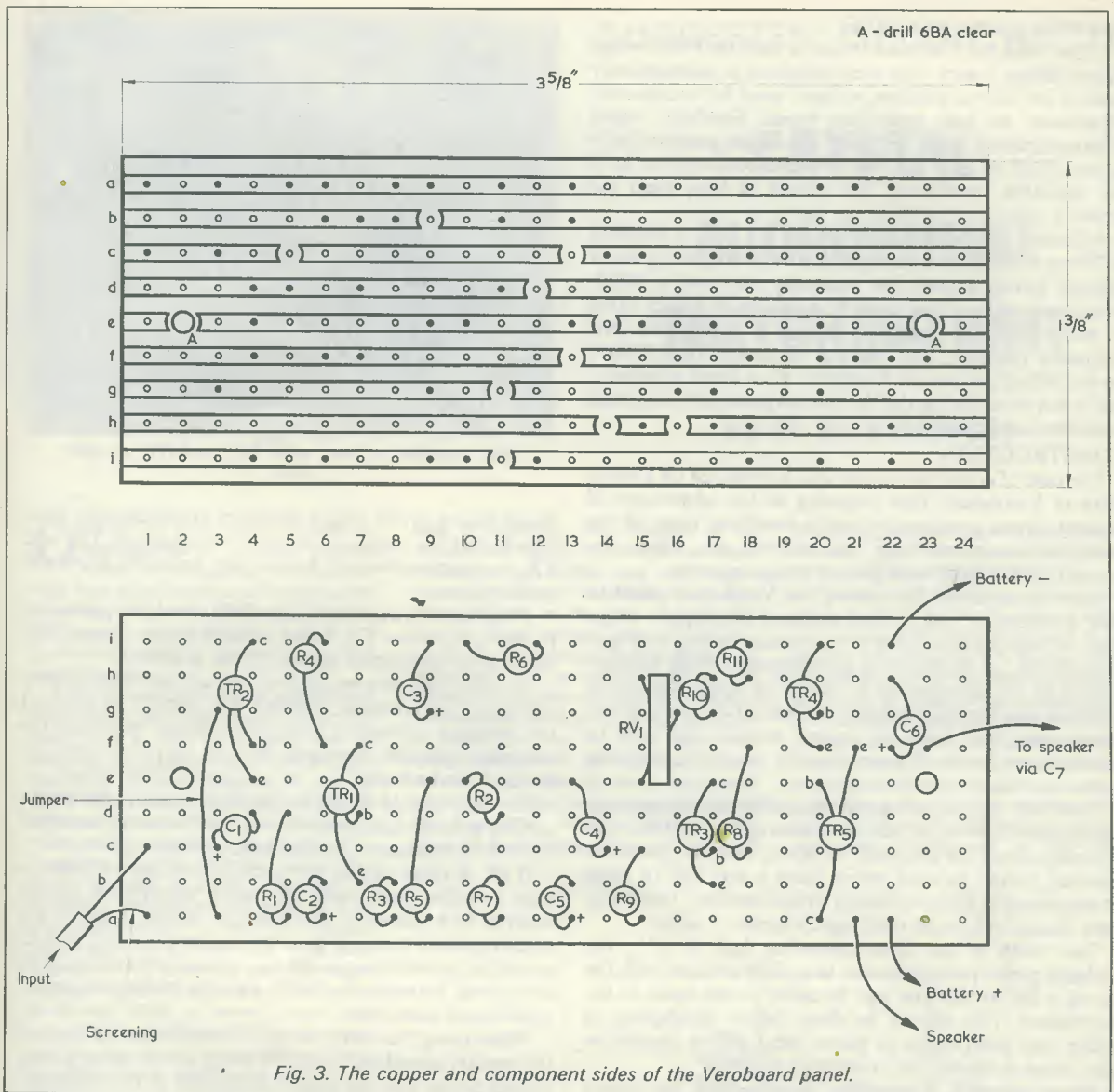

Fig. 3. The copper and component sides of the Veroboard panel.

Having cleared up all these basic factors, we can return now to the full circuit diagram of the unit, as shown in Fig. 1, and consider the final development details of the amplifier circuit.

It will be noticed that TR₃ has been provided with relatively low values of collector load resistance, the total resistance being approximately 650Ω ($R_{11} + R_{10}$). These values are dictated by the d.c. requirements of the circuit, and give only a relatively low value of voltage gain at a.c. Quite clearly, it is desirable to use the highest possible value of collector load if maximum gain is to be achieved, but this value is, unfortunately, dictated by the d.c. requirements. It is possible, however, to increase the effective value of the collector load without changing its real value by using bootstrapping, as shown in Fig. 1.

As will be seen, the collector load of TR₃ is split into two parts, with R₁₀ as the main collector load, and R₁₁ acting as an "isolating" resistor. The signal at the emitters

of TR₄ and TR₅ (which is of the same form and phase as that at TR₃ collector) is coupled to the junction of R₁₀ and R₁₁ via C₆, so that, when an input signal is available, similar a.c. signals appear at both ends of R₁₀. In consequence, only a very small a.c. signal current actually flows in this resistor, which therefore appears to have a far higher impedance than its real value. Typically, the effective value of R₁₀ may be increased to 10 times its real value by the use of this bootstrapping technique, without causing any change in its real or d.c. value. The gain is, thus correspondingly increased.

In practice, the effective value of the TR₃ collector load is almost equal to the input impedance offered by emitter followers TR₄ and TR₅, and the input impedances of these transistors are in turn equal to the product of the external speaker load and the transistor current gains. If a 15 Ω speaker is used and the output transistors have current gains of 100, the effective value of TR₃ collector

load tends to approach 1,500Ω.

From what has been said it can be seen that the overall circuit design is such that each transistor is automatically used to its full capabilities, without need for component adjustment to suit individual types. Similarly, when different speaker loads are used, the circuit automatically adjusts itself to give the best possible performance with the available transistors. The circuit is thus ideal for amateur use.

A final point concerns the value of C_7 . This is specified as 200 to 1,000μF. If the amplifier is used with a very small speaker having a poor low frequency response, a 200μF component will in most cases be adequate. A higher value is preferable with speakers having a reasonable low frequency response, and this can be greater than 200μF, up to 1,000μF, as desired. Capacitor C_7 is fitted externally, and is not mounted on the Veroboard panel with the other amplifier components.

CONSTRUCTION

For ease of construction the unit is wired up on a small piece of Veroboard, thus retaining all the advantages of printed circuit construction while involving none of the complications of marking out, etching, etc., which are normally associated with printed circuit practice.

Start construction by cutting the Veroboard panel to size, as shown in Fig. 3, and then cut the copper strips, with the aid of a small drill or the special cutting tool that is available, as indicated in the diagram. If the finished unit is to be mounted to a chassis or small sub-panel, drill two small mounting holes to clear 6 BA screws where shown, and trim back the copper around the holes to eliminate any risk of short circuits when the securing screws are fitted in place.

Next turn the panel over and assemble the components and leads on the blank side, as shown in Fig. 3. Note that all components are mounted vertically, and that insulated sleeving should be used where there is any risk of wires or components short-circuiting to one another. Transistor cans should not touch other components or wires.

The width of the three mounting legs of RV_1 , the skeleton preset potentiometer, should be reduced with the aid of a file so that the legs fit easily in the holes in the Veroboard. This should be done before attempting to solder this component in place. Heat shunts should be used when soldering the transistors in place.

When assembly is complete, double-check the wiring and make sure that there are no short circuits between the copper strips. If all is satisfactory, the circuit can be given a functional check.

Set RV_1 to minimum resistance (slider towards TR_3) and short-circuit the input terminals. Now connect a 9 to 12 volt supply, taking care to monitor the total current

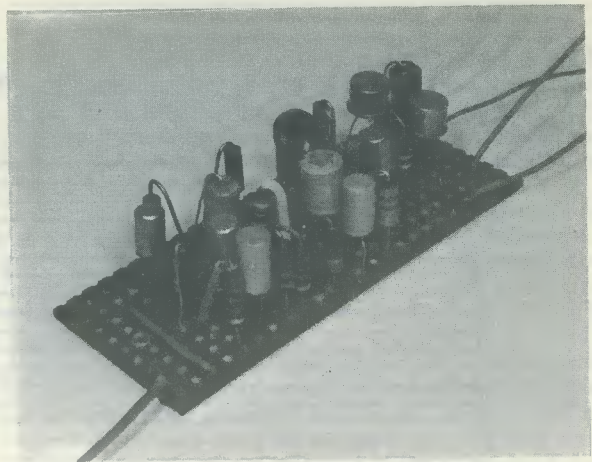

The amplifier as seen with TR_4 and TR_5 at right rear.

drawn by the circuit, which should be approximately 8mA. Check that the common emitter connection of TR_1 and TR_5 is at approximately half supply potential above the positive line.

If satisfactory, a speaker (15 to 25Ω) should be connected to the output via C_7 . There should be no appreciable increase in the current drawn by the amplifier.

An input can now be applied via screened wire and the quality of reproduction checked. RV_1 should be adjusted to minimise crossover distortion while enabling the minimum possible no-signal current (approximately 10 to 12mA) to be drawn.

The unit should finally be run for a reasonable length of time at fairly high power levels, and a check made that there is no tendency towards thermal runaway.

If all of these checks are satisfactory, the amplifier is now complete and ready for use. If required, it can be secured to a chassis or sub-panel by means of two 6 BA screws passed through the two mounting holes. P.V.C. or rubber grommets passed over these screws should be interposed between the panel and the chassis to act as spacers and insulators.

When using the unit it should be noted that the greater the speaker impedance used, the lower will be the available output power and the better the quality of reproduction. Conversely, if a low impedance speaker is used, maximum output power will be increased. A speaker impedance of 15Ω should give the most satisfactory results.

No on-off switch is shown in the circuit or Components List. Such a switch may be fitted externally in series with either of the supply lines, if desired.



"DEVELOPING THE 'MINIFLEX' CIRCUIT"

Some readers building the receiver described under this title in the July 1968 issue have reported difficulty in obtaining the transformer specified in the Components List for T_1 . Although available at the time of publication this transformer has apparently since been discontinued. A suitable alternative is the Repanco TT4, this being connected into circuit as follows: blue and yellow (or white) together; black to emitter of TR_2 ; green to negative line; orange (or red) to base of TR_3 . The alternative colours in brackets are given as some transformers have slightly different shades of colour for the leads.

CRYSTAL MICROPHONE MATCHING UNIT

by G. A. FRENCH

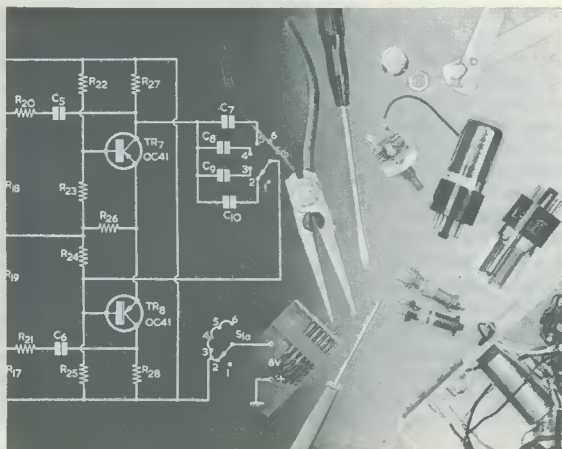

ONE OF THE MOST USEFUL CLASSES OF microphone for general purpose work is the crystal microphone. This type of microphone exhibits a good frequency response, offers high sensitivity, and is available at low cost. It is a particularly popular choice for use with tape recorders.

Unfortunately, the crystal microphone suffers from one major disadvantage, this being that it must be coupled into an amplifier input circuit offering a very high resistance if bass response is not to suffer. The reason why a high input resistance is needed is that the crystal microphone consists basically of a generator in series with a capacitor (the latter having a value, typically, of 1,500pF) whereupon too small a load resistance results in the lower audio frequencies being attenuated. With most crystal microphones the amplifier input resistance should be at least 2M Ω , and preferably 4M Ω or more. Some commercially manufactured tape recorders employing crystal microphones have amplifier input resistances as high as 10M Ω .

The provision of input resistances as high as this raises problems in amplifier design, regardless of whether the amplifier employs transistors or valves. With transistor amplifiers the main problem is to devise an input circuit which provides the requisite high input resistance despite the fact that transistors are essentially low impedance devices. With valves the input resistance is normally provided by the grid leak of the first amplifier valve, and it is by no means an easy task to prevent hum pick-up when this grid leak has a very high value. It has to be remembered, here, that there will be considerable amplification after the grid of the first valve and that the hum pick-up is most likely to result from stray couplings to the heater circuit.

This month's article in the Suggested Circuit series presents a very simple solution to the input resistance problem,

and it describes two versions of an inexpensive circuit which offers an input resistance of 10M Ω and an output impedance of lower than 1k Ω , this change being effected at the cost of negligible loss in signal voltage from the microphone. In one version the circuit may be interposed as a self-contained unit between the crystal microphone and any a.f. amplifier having an input resistance of about 2.5k Ω or more. In the second version the circuit may be built into a valve a.f. amplifier between the crystal microphone input socket and the grid of the first valve, thereby enabling the latter to have a low value grid leak and

completely eradicating the hum pick-up difficulty just referred to.

SELF-CONTAINED UNIT

The circuit of the self-contained unit is given in Fig. 1. In this diagram it will be seen that a field effect transistor is employed, this being the R.C.A. type 40468. The 40468 is an N-channel depletion f.e.t., and is available from Amatronic, Ltd. It has an insulated gate and, for all practical purposes in the present context, may be assumed to present infinite input impedance.

In Fig. 1 the 40468 is employed as a "source-follower", this being a mode of operation reminiscent of the valve

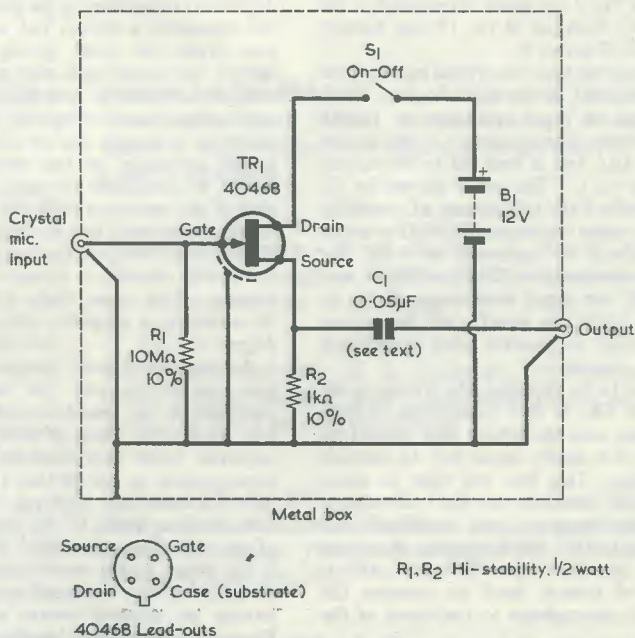

Fig. 1. A self-contained unit which enables a crystal microphone to be coupled to any a.f. amplifier having an input resistance in excess of 2.5k Ω .

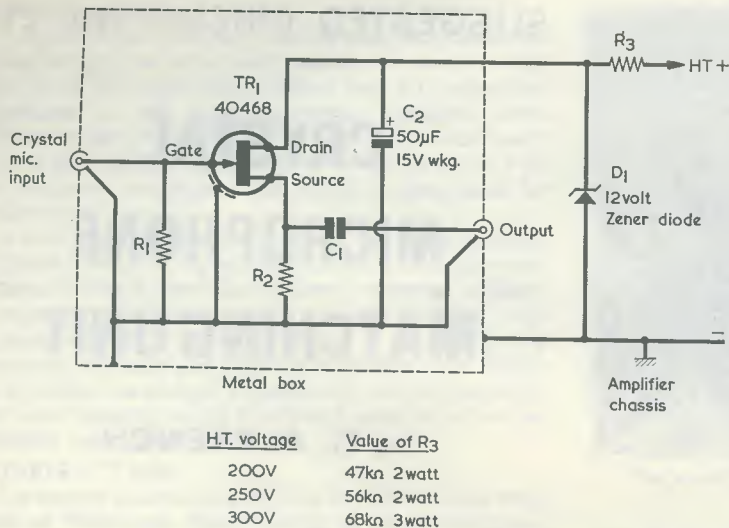

Fig. 2. An alternative circuit which may be installed in a valve a.f. amplifier.

cathode follower. The gate is maintained at chassis potential by means of R_1 , whilst R_2 provides gate-source bias. Again, the similarity with a valve becomes evident: the gate is intended to be biased negative of the source, whereupon the requisite bias is dropped across R_2 in the same manner as cathode bias is provided with a valve. For N-channel depletion operation the drain is positive, and in Fig. 1 the drain is returned to the positive terminal of the 12 volt battery via on-off switch S_1 .

To use the unit, the crystal microphone is connected to the input socket, which presents an input resistance of 10MΩ. The output signal appears at the source of the f.e.t. and is then fed to the output socket via C_1 . The value shown for C_1 is suitable if the subsequent a.f. amplifier has an input resistance of 250kΩ or more. C_1 should be increased to 0.5µF for input resistances of 25kΩ to 250kΩ, and to 5µF for input resistances of 2.5 to 25kΩ. In the last case C_1 will be electrolytic, with its positive plate connecting to TR_1 source.

As is to be expected, the wiring to the gate of TR_1 is very susceptible to hum pick-up, and the whole unit should be fitted in a small metal box to provide screening. This box will then be automatically earthed to the subsequent amplifier chassis via the braiding of the screened cable which couples its output to the amplifier input. Screened cable is also, of course, used to connect the crystal microphone to the input of the unit.

The current consumption from battery B_1 , as checked in the prototype, is a little in excess of 1mA only. In consequence, B_1 need only be small in physical size.

Eight "pen-light" cells (for which holders are available from Home Radio and other stockists) would be quite suitable. Switch S_1 can be a standard toggle component fitted to one panel of the metal box.

The symbol shown for TR_1 follows the practice currently in use in this country for depicting field effect transistors, but it allows a small ambiguity to creep in. A chassis connection to the metal case of the transistor is shown but, as may be seen from the inset giving lead-out layout, this connection also goes to the channel substrate as well. In the present application, connecting the case and substrate to chassis has no effect on the actual operation of the transistor. It would be preferable to ensure that the case of the transistor does not touch the inside of the metal box in which the unit is assembled. Despite the fact that both are at the same d.c. potential, such a contact might cause slight crackling if the subsequent amplifier offered a high degree of gain.

An important point is that the f.e.t. gate insulation can be irreparably damaged if the gate-to-source voltage falls outside the limits of zero to 8 volts negative. Great care must be taken, in consequence, to ensure that there is no risk of accidentally applying a potential outside these limits to the input socket of the unit. This risk would be lessened if the input socket were a phone jack rather than, say, a coaxial aerial socket having an exposed centre conductor. Precautions to prevent breakdown of the gate insulation must also be observed during wiring up. Breakdown can, for instance, easily occur if an unearthed mains soldering iron bit is applied to the

gate lead. The author's approach here is to initially wire an Eagle TS-10 4-way transistor holder into circuit first, and to fit the f.e.t. to this after all the wiring has been completed and checked.

As was mentioned earlier, the current consumption from the 12 volt battery is slightly in excess of 1mA. The f.e.t. is well on the linear part of its gate/source voltage characteristic at this current, which appears to be more than adequate for the present application. As a point of interest, the writer checked operation at source currents of 2mA and 3mA but there was no noticeable change in performance. These increased source currents were given by values in R_2 of approximately 500Ω and 250Ω respectively.

The circuit of Fig. 1 was tested in prototype form with an Acos 40 crystal microphone and a standard valve a.f. amplifier having an input resistance of 500kΩ, and it functioned quite satisfactorily. As already mentioned, the wiring to the gate of TR_1 is particularly sensitive to hum pick-up, and the metal box must provide complete screening. With the prototype, there was no significant decrease in microphone sensitivity at higher frequencies with the unit interposed between the microphone and the amplifier as compared with the microphone connected to the amplifier direct, although the unit did, of course, provide the high input resistance needed for good bass response. The makers of the Acos 40 microphone specify a load of not less than 4.7MΩ for correct frequency response, and state that low frequency cut-off is given by $F = \frac{80}{R}$

where F is in c/s and R is in megohms. The 500kΩ input resistance of the author's amplifier on its own would thus have caused a low frequency cut-off of 160 c/s. Similar load resistance figures will apply for other crystal microphones of the same type.

So far as could be ascertained by subjective tests, the f.e.t. introduced no noticeable noise in the microphone input circuit.

ALTERNATIVE CIRCUIT

Some constructors may desire to incorporate the f.e.t. unit in an existing valve a.f. amplifier in order to provide a high resistance input for crystal microphones. This requirement is covered by the second circuit for this month, which is shown in Fig. 2. The circuit of Fig. 2 has not been tried out by the writer, but it is exactly the same as Fig. 1 apart from the power supply arrangements. R_1 , R_2 and C_1 have the same values as in Fig. 1.

Power is obtained from the h.t. positive rail of the amplifier via dropping resistor R_3 and zener diode D_1 . R_3 should have a resistance which allows some 4 to 5mA to flow from the h.t. supply to the zener diode and f.e.t. unit, and calculated

values for h.t. voltages of 200, 250 and 300 are given in the diagram. D_1 can be any 12 volt zener diode with a tolerance of 10% or better and capable of passing 5mA (or of dissipating 60mW). A wide variety of suitable diodes is available from component stockists, including the Z1112-C (Cat. No. SD68) from Home Radio or the Z12 from Henry's Radio. Capacitor C_2 is added, inside the metal screening box, to provide a low supply impedance for the f.e.t. circuit and to decouple any a.f. voltages which might be present on the amplifier h.t. line. (The slope resistance of the zener diode on its own may not be sufficiently low to provide an adequate bypass). Most standard a.f. amplifier h.t. power supplies should be capable of providing the small

extra current required by the circuit of Fig. 2.

Again, all the a.f. components in Fig. 2 are mounted in a metal box which provides complete screening. Since it does not now contain a battery, this box can be very small in size and it should be a simple matter to find space for it in a standard valve amplifier chassis. The output connects directly to the grid of the first a.f. amplifier valve, which can be provided with a low value grid leak – say 47k Ω or even less. This, in combination with the low output impedance of the f.e.t. unit, will make the grid circuit considerably less susceptible to hum pick-up than would occur if it had the very high value of grid leak required for direct connection to the

microphone.

All the safety precautions needed to prevent breakdown of the f.e.t. which were detailed for Fig. 1 apply equally to Fig. 2.

The f.e.t. units of Figs. 1 and 2 could be used to accommodate other a.f. signal sources which require high load resistances. Since the standing voltage across R_2 is only of the order of 1 volt it is probable, however, that linear amplification could only be expected for input signal levels up to some 0.5 volts peak.

As a final point, the circuit of Fig. 2 could also be incorporated in a transistor amplifier, assuming that suitable arrangements could be made to provide the 12 volt supply.



CAN ANYONE HELP ?

Requests for information are inserted in this feature free of charge, subject to space being available. Users of this service undertake to acknowledge all letters, etc., received and to reimburse all reasonable expenses incurred by correspondents. Circuits, manuals, service sheets, etc., lent by readers must be returned in good condition within a reasonable period of time

Transmitter TA12B.—R. Harris, 64 Frederick Place, Llansamlet, Swansea, Glam. – manual or circuit, also any details of modifications.

B44 MkIII Receiver.—A. Jones, 73 Newfield Drive, Crewe, Cheshire. – any information about this receiver, especially details of conversion to 70 Mc/s. Purchase of manual or circuit diagram.

Canadian Marconi 52 set.—GI3GRD, Kesh, Enniskillen, Co. Fermanagh, N. Ireland. – complete alignment details.

Hallcrafters Super Skyrider.—M. A. Nash, 4 Woodside Close, Tolworth, Surbiton, Surrey. – loan or purchase of circuit or manual for this receiver.

R107 Receiver.—D. E. Garner, 52 Culvers Way, Carshalton, Surrey. – details of modifications allowing for fitment of an 'S' meter, also information on any other improvements.

Indicator Unit 166A.—B. Franklin, 58 Brookfield Avenue, Runcorn, Cheshire. – circuit or manual and any other information on conversion to an oscilloscope.

Wireless Set No. 19 MkIII.—G. R. Hurst, 10 The Drive, Tynemouth, North Shields, Northumberland. – circuit diagram, or any other information, of B. Set and I.C. Set. Loan or purchase.

Transistor Intercom.—B. B. Rafter, 18 South Road, Oundle, Peterborough. – Aiphone model ESI, or similar, circuit diagram, loan or purchase.

Ace Radio Model 600.—R. K. Simmons, 154 Alderwood Road, Eltham, London, SE9. – circuit diagram or service manual of this 9 waveband receiver.

Raymond 5-Valve Receiver.—T. F. Jones, 4 Dencil Close, Colley Gate, Halesowen, Worcs. – loan or purchase of manual or circuit. This receiver (serial No. A44856) is fitted with two speakers.

Tube Unit Type 266.—J. Gaunt, 6 Moorland View, Emlay, Nr. Huddersfield, Yorks. – circuit diagram or any other information on this ex-R.A.F. unit. Loan or purchase.

A 2 METRE GROUND PLANE ANTENNA

by

A. C. GEE G2UK

THE TRANSMITTING AMATEUR WHO WANTS TO USE amateur transmitting equipment on a yacht, has two alternatives. He can either apply to the G.P.O. Licencing Authorities for a /MM - maritime mobile - licence, which is expensive and contains a number of restrictive clauses, or he can operate /P, using his normal amateur transmitting licence. In the latter case, the craft must not be under way, but must be moored or at anchor at a fixed location.

The appropriate section of the Amateur (Sound) Licence A states: "(ii) any premises (hereinafter called 'the temporary premises') for separate periods none of which shall exceed four consecutive weeks". Also, in that section of the Licence dealing with "Call Sign and Notification of Location", we read: "(c) at the temporary location the Suffix 'P' shall be added to the call sign".

CHOICE OF AERIAL

Most folk with boats are more likely to be interested in operating amateur radio gear in them when they are stationary rather than when they are under way, and this was certainly the case where the author is concerned. The aerial does not then have to be a fixture on the yacht, which helps matters considerably. Again, the conventional type of 2 metre antenna does not lend itself well to installation on a boat, particularly if it is of the beam variety. Such an antenna is in fact hardly practical on a boat, and something in the nature of an omni-directional aerial is much more desirable. A consideration of the various types of these made it quite apparent that the ground plane aerial was the most suitable, primarily because of its physical configuration.

The next problem to consider was its mounting. If /P operation solely was to be used, it would not have to be a permanent fixture. Could it, for instance, be slung up in the rigging? The obvious thing seemed to be to fix an insulator to the top of the radiating section of the aerial, fix a hook to the top of the insulator and hoist the aerial up beneath the crosstree of the yacht mast, and this has in fact proved to be a thoroughly practical solution, as can be seen from the accompanying photographs. Particularly is this so if the radials project downwards, as illustrated.

Reference to the literature gives the dimensions of an antenna of this type as:

$$\text{Length of radiator} = \frac{0.94\lambda}{4}$$

where λ is the wavelength in metres.

The value of λ is given by $\frac{300}{f}$, where f is the frequency in Mc/s. This gives the result in metres, which can then be converted, if desired, into inches. For a frequency of

145.25 Mc/s, which is the writer's operating frequency, the length works out in inches at approximately 19. The radials are usually made a half inch or so longer. Experience with this antenna has, however, indicated that the lengths are not unduly critical. (As is explained later, mechanical clearance requirements make it necessary to make the length of the actual vertical radiator rod slightly shorter than the calculated figure.)

CONSTRUCTIONAL DETAILS

The antenna was constructed for the writer in the metal workshop of the boat-yard which looks after his yacht. The first thing to do is to obtain a couple of suitable insulators. The base one is of the "beehive" standoff type, and the top one is a smaller egg shaped or globular shaped one with a threaded bush in each end. In the writer's case, the base insulator is 3in high, $1\frac{1}{2}$ in in diameter, with a base flange of $2\frac{1}{2}$ in diameter with four holes in it. There is a hole in the top of the base insulator, into which the radiating element is fixed. The top insulator has a diameter of $1\frac{1}{4}$ in. The sizes of the insulators are not particularly important, of course, and amateurs should be able to obtain similar types in surplus stores, etc., without too much difficulty.

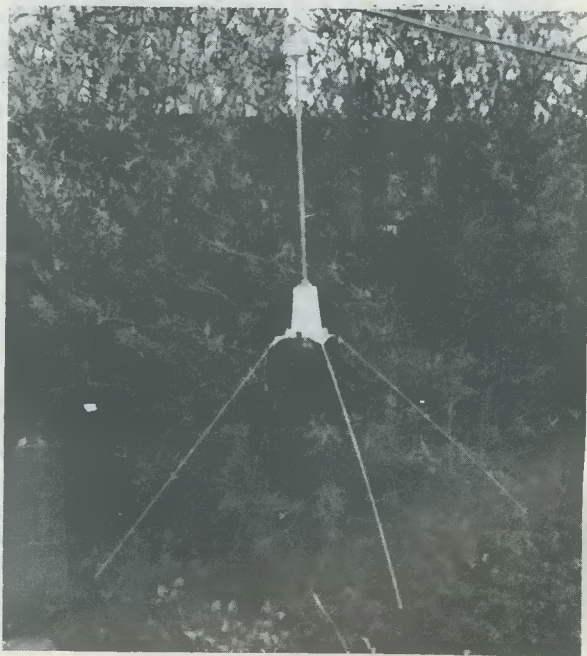

The completed aerial after assembly.

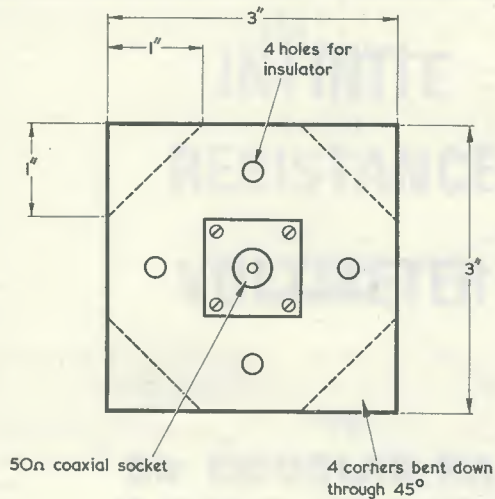

Fig. 1. The square brass plate, before bending. The four outside holes are positioned to suit the particular insulator employed.

The base insulator is bolted to a base plate about 3in square made of stout sheet brass. A hole large enough to accommodate a 50Ω coaxial chassis-mounting socket (Home Radio Cat. No. PK50B) is cut in the centre of this brass plate and the base insulator is mounted centrally over it. Beneath the insulator, and on the other side of the plate, the coaxial socket is fixed at this hole. A suitable coaxial plug (Home Radio Cat. No. PK50A) to suit the socket is required to connect the coaxial feeder to the aerial when completed. The impedance of this aerial is around 50Ω and, for best results, 50Ω cable should be used. A piece of stout copper wire is taken from the centre conductor tag of the coaxial socket to the hole at the top of the insulator, where it is clamped around the radiator element base by the nuts and washers that hold the radiator in the top of the insulator.

A suitable material for the radiator element is brass rod of $\frac{3}{16}$ in diameter, and this was used by the writer. The



The aerial hoisted to the yacht cross-tree.

top end is threaded to fit in the bush in the top insulator. The bottom of the radiator needs to be threaded for 3in or so, thus allowing plenty of scope for altering its effective length. A couple of nuts on the lower end of the radiator, with washers either side of the hole in the top of the insulator, fix the radiator element firmly to the insulator and by screwing the rod up and down in the hole, it can be adjusted for length when tuning up. Don't forget to clamp tightly the connecting wire from the centre conductor of the coaxial socket after each adjustment of radiator length.

The radials are made from hard drawn brass rod, and the material used for brazing suits well. They are brazed

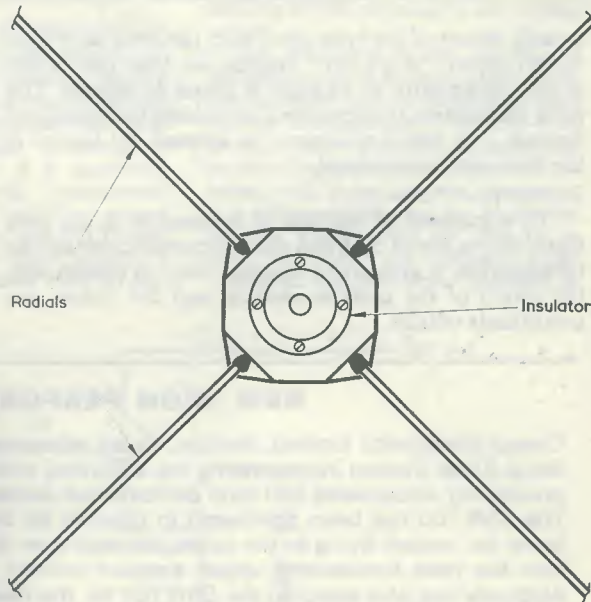
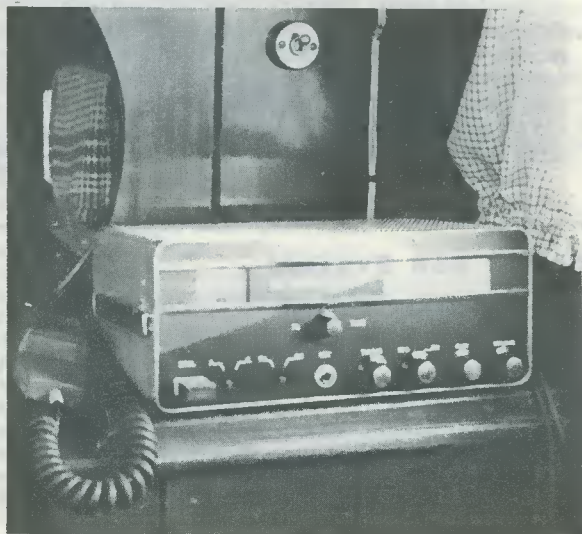

Fig. 2. Top view before the radiator element is fitted.



The operating position in the writer's yacht.

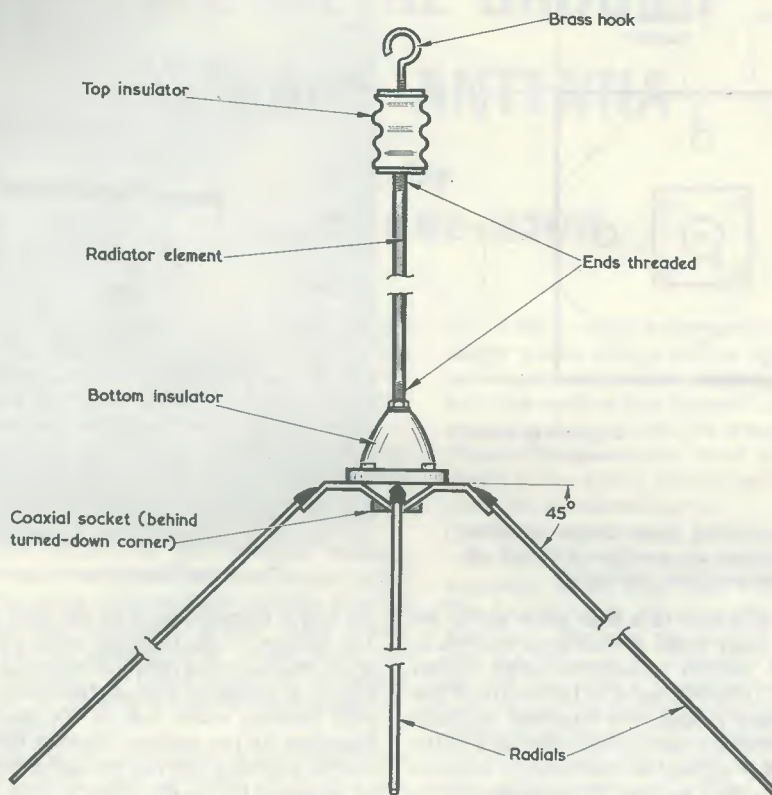

Fig. 3. Side view of the completed aerial.

to each corner of the brass plate after the latter have been turned down "dog's ear" fashion, so that the radials project downwards at an angle of about 45 degrees. This gives the antenna an appearance resembling the traditional Sputnik - by which nickname the antenna got known in the boat-yard metal shop!

TUNING

The impedance of this type of antenna is, as has been stated above, about 50Ω , and suitable coaxial cable should be employed. It appears to be quite "flat" in tuning, with the length of the radiator element and the radials not particularly critical.

If a 2 metre grid dip meter or field strength meter is available, the length of the radiator can be easily adjusted for maximum radiation by screwing it in and out of the mounting insulator. However, a good performance can be obtained by simply adjusting the effective length of the radiator (measured from the brass plate surface to the radiator top) to the theoretical length calculated as outlined above for the frequency to be used. This means that, when originally cut, the length of the actual radiator rod should be a little shorter than its calculated length in order to provide clearance at its lower end. *

NEW HIGH PERFORMANCE SSR SYSTEM

Cossor Electronics Limited, Harlow, Essex, announce the introduction of the CR.700 Secondary Surveillance Radar System incorporating the advanced solid state SSR.700 transmitter/receiver, a variety of video processing equipments and high performance aerials.

The SSR.700 has been purchased in quantity by the British Government, further to improve the airways cover for aircraft flying in the upper airspace over the United Kingdom. Data from one system will be fed into the new Eurocontrol upper airspace control centre at Maastricht. The Norwegian Civil Aviation Authority has also selected the SSR.700 for the new automatic SSR System to be installed at Oslo International Airport.

This new policy of offering a choice of video processing equipment to meet the differing requirements of users means that the joint promotion of the Cossor/Elliott CE.70 System will cease from September 1968.

INFINITE RESISTANCE VOLTMETER

by
**Sir DOUGLAS HALL,
K.C.M.G., M.A. (Oxon)**

A voltage measuring device familiar in the school physics laboratory is brought up to date in this article. The simple voltmeter described here is intended for measuring direct voltages in transistor equipment and, when finally set up, draws no current at all from the circuit to which it is connected.

THE MOST COMMON METHOD OF measuring voltage in radio equipment consists of employing a meter with a series resistor. It is seldom that a meter with a greater sensitivity than that given by a full scale deflection of $50\mu\text{A}$ is used. With such a meter, a resistance of $20\text{k}\Omega$ is required for a full scale deflection of 1 volt, $200\text{k}\Omega$ for 10 volts and so on. The sensitivity is thus quoted as $20\text{k}\Omega$ per volt, and a resistance, based on this relationship, is consequently applied across two points in a circuit whenever the potential difference between them is to be measured. A voltmeter employing transistors can easily be made to have an input resistance of $3\text{M}\Omega$ or more, and a valve or f.e.t. voltmeter can offer an even higher resistance, of the order of $10\text{M}\Omega$. All these instruments exhibit a load resistance of some sort across their test terminals and, even when high, this can still sometimes result in a reading which is sufficiently inaccurate to require the application of Ohm's law for necessary correction. Suppose, for example, that a constructor wishes to measure the voltage drop across a $1\text{M}\Omega$ resistor which is being used to apply base bias to a transistor. He may well use a good instrument with a sensitivity of $20\text{k}\Omega$ per volt but, even then, on the 10 volt range he will shunt a load of $200\text{k}\Omega$ across a resistor which has 5

times this value, and the resulting measurement will be very far from the voltage which exists under working conditions.

INFINITE INPUT RESISTANCE

The instrument to be described in this article has an input resistance which is dependent solely on accuracy of reading and insulation of components and which can, for all practical purposes, be described as infinite. It is specifically designed for use with transistorised apparatus and has only two ranges, these being 0-9 volts and 0-1.5 volts. Although, so far as direct voltage is concerned the instrument offers no load

to the apparatus under test, it does have some self-capacitance and is therefore capable of causing a change from normal working conditions when connected to circuits carrying high frequency currents. For example, in some circumstances it can cause delicately adjusted apparatus to become unstable while under test. This, of course, applies to all forms of measuring instrument.

The basic circuit is shown in Fig. 1, and the author hastens to say that he does not claim originality for a device which, in very large and expensive form, has been used in physics laboratories over many years for very accurate measurement of voltages (and which is, interestingly enough, known as a "potentiometer" in a laboratory) but he has not previously seen a small edition designed for use by home constructors.

The principle is extremely simple. M is a centre-zero meter with a deflection of plus or minus $50\mu\text{A}$. B is a 9 volt battery, fairly large in comparison with the small current it has to provide in order that it may maintain a steady potential difference between its terminals, whilst VR is a wirewound potentiometer having a scale calibrated in voltage. If VR is set to zero and the test leads are applied to a source of voltage, a reading will be given on the meter. If VR is then adjusted to apply a balancing voltage from B, a point will be reached when no current flows through the meter whereupon this consequently registers a zero reading. The voltage across the test leads can then read from the previously calibrated scale of VR. As no current flows through M at the point of correct adjustment there is, at d.c., no load across the test leads, and an accurate reading is given however high the circuit resistance at the voltage source.

The accuracy of the reading is independent of the accuracy of the meter, but this meter must be sensitive to small current changes, which is why a 50-0-50 μA type is chosen. Accuracy is dependent on the voltage across the terminals of the battery and, in the complete instrument, it is recommended that the battery be changed about every six months to avoid inaccuracies due to falling voltage. This effect will, in practice, be small, as

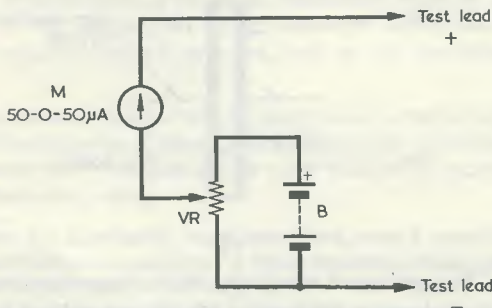

Fig. 1. Circuit illustrating the basic principle employed in the voltmeter.

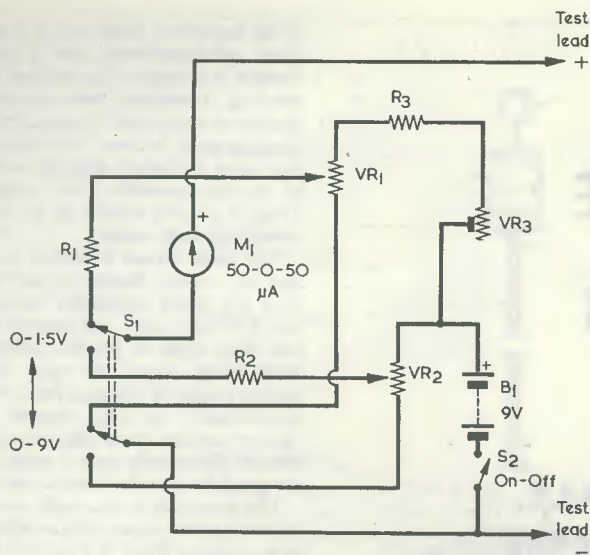

Fig. 2. The complete circuit of the instrument.

the current drawn is merely some 300 to 350 μA , and that only when the instrument is switched on. The discarded batteries will still have plenty of useful life for other purposes.

FULL CIRCUIT

The full circuit of the instrument is

shown in Fig. 2. Separate potentiometers are used for the two ranges, as the use of one high resistance potentiometer with a series resistor for the 1.5 volt range would decrease the sensitivity and make accurate adjustment difficult. On the 1.5 volt range VR_1 , a 5k Ω component,

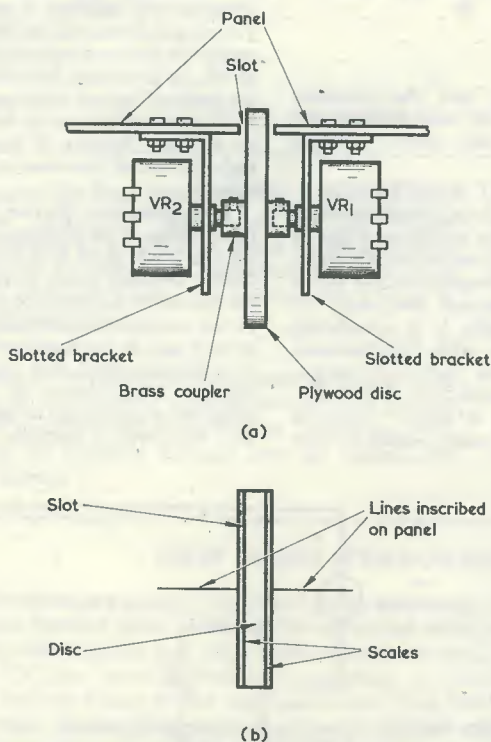

Fig. 3(a). A simple means of coupling the two potentiometers together.
 (b). Scale markings on the sides of the disc are read off against lines inscribed on the front panel.

COMPONENTS

N.B. Additional components to those listed here (see text and Fig. 4) are required for calibration.

Resistors

(All fixed values $\frac{1}{4}$ watt 10%)

- R_1 30k Ω
- R_2 180k Ω
- R_3 20k Ω
- VR_1 5k Ω wirewound potentiometer, Colvern, Cat. No. VR22C (Home Radio)
- VR_2 30k Ω wirewound potentiometer, Colvern, Cat. No. VR22C (Home Radio)
- VR_3 10k Ω wirewound potentiometer, preset

Meter

- M_1 50-0-50 μA meter, Sew type MR38P (Electroniques) or similar. See text

Switches

- S_1 2 pole 2 way, toggle
- S_2 1 pole 1 way, toggle

Battery

- B_1 9 volt battery type PP6 (Ever Ready)

Hardware

Brackets, coupler, plywood, etc. See text.

is used in series with R_3 and VR_3 which, together, provide a resistance of about 25k Ω when VR_3 is correctly adjusted. R_1 is a series resistor to limit the current which can flow through the meter to a safe value when measurements are being made. VR_2 , a potentiometer of 30k Ω , is used for the 9 volt range, R_2 performing a similar limiting role on that range. S_1 changes the instrument from one range to the other and S_2 is used to prevent current drain while the instrument is not in use. It is important to remember to switch off S_2 or the battery voltage will fall earlier than it should.

There are no problems of layout and it is quite in order for VR_1 and VR_2 to be mounted separately, each with its own scale. It is somewhat neater to gang the two together as shown in Fig. 3(a). Each is mounted on a slotted bracket and the spindles are joined by a brass coupler which has a plywood disc, $\frac{1}{4}$ in thick, cemented onto it. This disc has a paper scale glued on either side, each used for calibration, whilst a rubber band round the disc gives a neat appearance and a good grip. A slot is needed in the panel as shown. See Fig. 3(b). In calibrating the scales it is best to make light pencil marks in the first instance and then dismantle the components in order to allow the disc to be removed for a neat,

final calibration. It is clear that the grub screws in the coupler must be tightened such that each potentiometer has its slider at one end of its track at the same time.

CALIBRATION

In order to calibrate the instrument it is necessary to have available a separate voltmeter, a new, separate, 9 volt battery, a new 1.5 volt cell, and a potentiometer of anything from $5k\Omega$ to $25k\Omega$. These components are connected up as shown in Fig. 4. Starting with the 9 volt range, and using the separate 9 volt battery in the battery position shown in Fig. 4, the external potentiometer is adjusted to cause 0.5 volts to be indicated by the meter in Fig. 4. The instrument being calibrated has S_2 switched on and S_1 set to the 9 volt range, after which VR_2 is adjusted to give a zero reading in M_1 . A pencil mark is then made on the appropriate paper scale on the disc, or on whatever other type of scale is employed. The process is repeated in steps of 0.5 volts up to 9 volts. Intermediate marks of 0.1 volt spacing can be made later by eye. The 1.5 volt cell is then substituted in Fig. 4 and the potentiometer of Fig. 4 adjusted to give a reading of exactly 1.5 volts. S_1 in Fig. 2 is switched to the 1.5 volt range and VR_3 is then adjusted so that M_1 gives a zero reading with VR_1 at maximum. Calibration in steps of 0.1

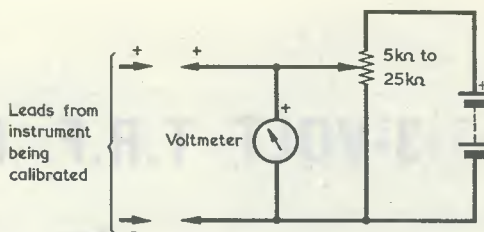

Fig. 4. The external components required for calibration.

volt are made on the other scale, in the same manner as with the 9 volt range, subdivisions of 0.02 volt (20mV) being made later by eye.

Although it is unlikely that any harm could be done to any apparatus, however the instrument might be adjusted when first connected up, it is a wise precaution to arrange that VR_1 , or VR_2 as the case may be, is always at zero setting when connections are made to the circuit being tested. Under these conditions no voltage will appear across the test leads from the internal battery. VR_1 , or VR_2 , is then adjusted to zero the meter. It is, of course, both permissible and necessary to rock VR_1 or VR_2 backwards and forwards a little at the zero reading, to make sure that this is accurately arrived at.

ALTERNATIVE METER

Some constructors may already have on hand, or prefer to use, a standard 0-50 μ A meter, and it is quite in order to employ this in place of the 50-0-50 μ A centre-zero meter shown in Fig. 2, provided that the precaution just mentioned is always observed. If VR_1 , or VR_2 , is at the zero position when connections are first made to the circuit being tested, then the deflection of a standard 0-50 μ A meter in the M_1 position will always be in a forward direction. (This, of course, assumed correct polarity at the test points in the circuit being test checked.) VR_1 , or VR_2 , is then adjusted for zero deflection in the meter, as with the 50-0-50 μ A movement, and there is no confusing, or excessive, reverse deflection.



EMI ELECTRONICS AT SBAC FARNBOROUGH

The main exhibit by EMI Electronics at this year's SBAC show at Farnborough was an actual Reconnaissance Pod designed and built for the F4M Phantom Aircraft.

EMI originated and developed the concept of the detachable reconnaissance pack, in the form either of a pod for mounting beneath the fuselage or a pallet replacing the bombs in the bomb-bay. The economic aspects of this type of equipment have caused it to find favour with the air forces of the world, as it enables an aircraft to undertake a strike or reconnaissance role as required with a conversion time of less than one hour. Contained in the Phantom's pod are three separate reconnaissance systems: sideways looking radar, infra-red line scan and photographic cameras. In addition the pod carries a data converter and buffer store for supplying navigational information to the various reconnaissance systems, and an air conditioning system.

Also shown was the EMI-Cossor Type 4 lightweight automatic direction finding equipment, which includes several new features. There is virtually no restriction on the distance at which the antenna may be located in relation to the receiver—due to the use of sense antenna pre-amplifier and a new matching technique. The equipment operates in the 100 kc/s to 3000 kc/s frequency range.

Other items exhibited by EMI will include CCTV for use on Concorde, tape recorders, and a special film display featuring some of the company's lesser known activities. In addition, a radar recorder developed by EMI Electronics, the function of which is to record and replay radar video signals and bearing and turning information, was exhibited on the Board of Trade stand and models of the latest EMI lightweight mortar locating radar, Cymbeline, being shown on the Ministry of Technology stand.

3-VOLT T.R.F. RECEIVER

by
G. W. SHORT

Operating from a 3 volt supply only, this neat receiver design offers loudspeaker reproduction either on medium waves only or on medium and long waves. It is assumed that the constructor is able to find the required turns on the ferrite aerial rod experimentally; this process is quite simple and detailed information is provided.

THE MAIN ATTRACTION OF OPERATING A RECEIVER from a low voltage battery, as far as the writer is concerned, is simply that 1.5 volt cells are so cheap, compared with the usual 6 volt or 9 volt batteries. The logical conclusion to this argument would be to use a single 1.5 volt cell to power the receiver. However, it turns out that in this case, as in others, it is dangerous to take

The receiver described here was therefore designed to operate from 3 volts. With pen-cells at less than sixpence each, compared with half a crown for the usual "transistor batteries", the economics is still very favourable. It is also possible, nowadays, to buy from component retailers neat little plastic holders which take a pair of pen-cells. By using one of these instead of a makeshift holder a significant

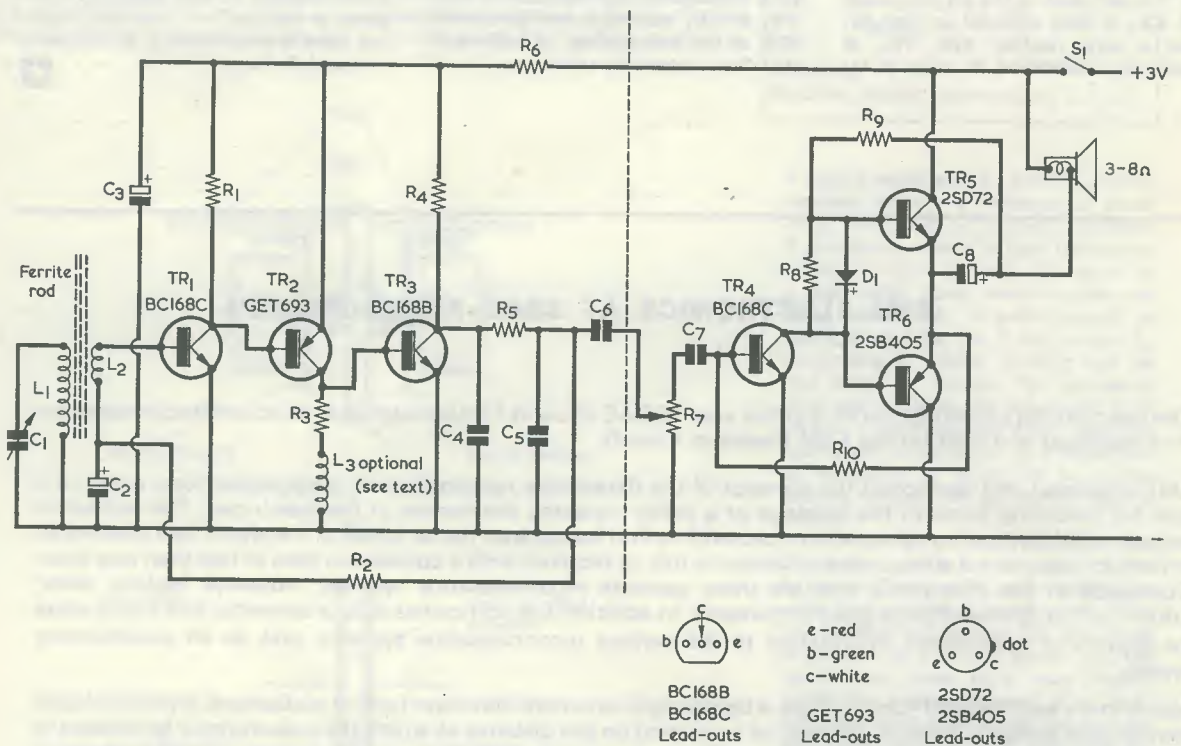

Fig. 1. The circuit of the 3 volt receiver. The ferrite aerial coils, L_1 L_2 , are intended for medium wave reception only.

things straight to their logical conclusion. When loudspeaker reception is required, and one of the now-popular "transformerless class B" output stages is envisaged, the efficiency of a 1.5 volt circuit is too low.

increase in reliability is obtained.

"CIRCUIT BLOCK" DESIGN

The design shown in Fig. 1 is really a combination of
(continued on page 163)

THE RADIO CONSTRUCTOR

RADIO CONSTRUCTORS DATA SHEET

14

MULTIVIBRATOR C-R VALUES

In a symmetrical germanium transistor square wave multivibrator, frequency is approximately equal to $\frac{1}{1.4CR}$ where C is either of the cross-coupling capacitors and R is either of the base-to- V_{cc} resistors. The Table gives worked R values to 2 significant figures against C and frequency. In general, R values between 10 and 100k Ω will be most commonly employed in practice. With silicon transistors, frequencies will tend to be slightly lower than those shown.

Frequency	500pF	1,000pF	2,000pF	5,000pF	0.01 μ F	0.02 μ F	0.05 μ F	0.1 μ F	0.2 μ F	0.5 μ F
50c/s					710k Ω	710k Ω	290k Ω	140k Ω	71k Ω	29k Ω
100c/s				960k Ω	480k Ω	360k Ω	140k Ω	71k Ω	36k Ω	14k Ω
150c/s				710k Ω	360k Ω	240k Ω	96k Ω	48k Ω	24k Ω	9.6k Ω
200c/s				480k Ω	240k Ω	180k Ω	71k Ω	36k Ω	18k Ω	7.1k Ω
300c/s				360k Ω	180k Ω	120k Ω	48k Ω	24k Ω	12k Ω	4.8k Ω
400c/s			890k Ω	290k Ω	140k Ω	89k Ω	36k Ω	18k Ω	8.9k Ω	3.6k Ω
500c/s		960k Ω	710k Ω	190k Ω	96k Ω	71k Ω	29k Ω	14k Ω	7.1k Ω	2.9k Ω
750c/s		710k Ω	480k Ω	140k Ω	71k Ω	48k Ω	19k Ω	9.6k Ω	4.8k Ω	1.9k Ω
1,000c/s	710k Ω	360k Ω	360k Ω	71k Ω	36k Ω	36k Ω	14k Ω	7.1k Ω	3.6k Ω	1.4k Ω
2,000c/s	480k Ω	240k Ω	180k Ω	48k Ω	24k Ω	18k Ω	7.1k Ω	3.6k Ω	1.8k Ω	1.4k Ω
3,000c/s	360k Ω	180k Ω	120k Ω	36k Ω	18k Ω	12k Ω	4.8k Ω	2.4k Ω	1.8k Ω	1.4k Ω
4,000c/s	290k Ω	140k Ω	89k Ω	29k Ω	14k Ω	8.9k Ω	3.6k Ω	1.8k Ω	1.4k Ω	
5,000c/s	190k Ω	96k Ω	71k Ω	19k Ω	9.6k Ω	7.1k Ω	2.9k Ω	1.4k Ω		
7,500c/s	140k Ω	71k Ω	48k Ω	14k Ω	7.1k Ω	4.8k Ω	1.9k Ω			
10,000c/s			36k Ω			3.6k Ω				

NOVEMBER— *ANOTHER EXCITING ISSUE!*

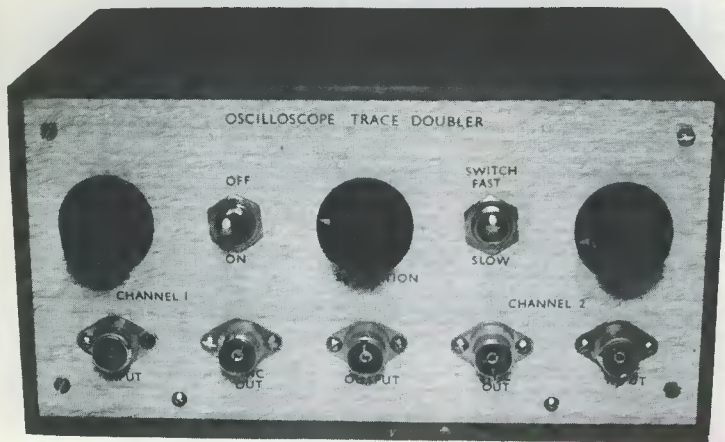

**OSCILLOSCOPE
TRACE
DOUBLER**

**PLUS
DATA SHEETS
16 AND 17**

RADIO CONSTRUCTOR

- 150 Watt Transmitter
- Low-Value Capacitance Bridge
- Inexpensive Intercom

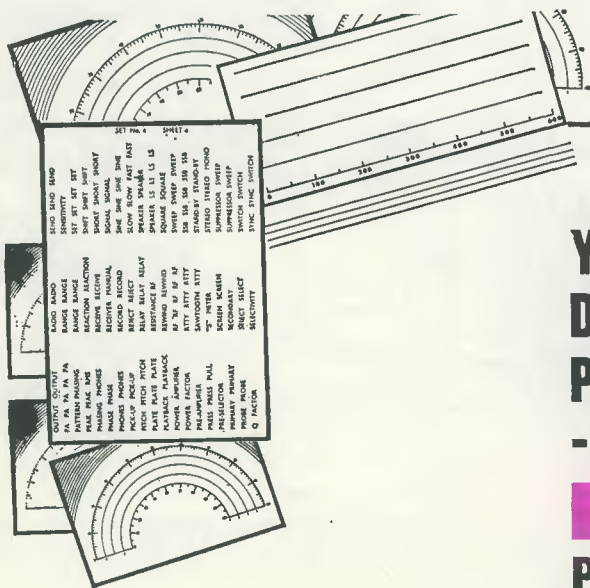

- ★ Set 3 Wording—WHITE
- ★ Set 4 Wording—BLACK
- 6 Sheets, over 1,000 words etc.
- ★ Set 5 DIALS—clear background
- ★ Set 6 DIALS—black background

**YOUR FINISHED ASSEMBLY
DESERVES A REALLY
PROFESSIONAL FINISH
-USE 'CONSTRUCTOR'
PANEL SIGNS
PERMANENT PAINT
TRANSFERS**

4/6 per set (postage 3d)

Send to:

DATA PUBLICATIONS LTD., 57 MAIDA VALE, LONDON, W.9

3-VOLT T.R.F. RECEIVER

(Continued from page 160)

two basic "circuit blocks" either of which may be used on its own. The first three transistors form a two-stage wide-band r.f. amplifier and detector; this part of the circuit (to the left of the dashed line) may be used as a radio tuner unit to drive an existing amplifier. The a.f. output is quite large (up to about 0.25 volt peak), and is sufficient to drive most types of amplifier. The remainder of Fig. 1 is a complementary class B transformerless audio amplifier, capable of being built into a small space, and of delivering 100mW into a speaker of 3 to 8Ω impedance.

The "tuner" part of the circuit consumes only 1mA, while the amplifier has a standby (no-signal) consumption of 3mA, and both will operate from fairly run-down cells.

TUNER SECTION

This is designed to give a good performance on medium or long waves even if "reaction" is not used. Many t.r.f. designs rely on reaction for their sensitivity, but good performance can then only be obtained at the price of critical adjustment of the reaction control. This circuit operates quite well without any reaction; selectivity on medium and long waves is quite good with a ferrite rod aerial, particularly if this is wound with Litz wire or fairly thick solid wire and the coupling to the first transistor is optimised. The only region in which better selectivity is then likely to be needed is the high frequency end of the medium-wave band, and a bit of preset reaction takes care of this.

The input stage uses a very-high-gain silicon planar transistor type BC168C. This is an epoxy-encapsulated transistor electrically identical to the metal-cased BC108, but selected for high gain ($h_{re} = 450$ to 900). Use of a high gain input transistor means that, with a two-stage r.f. amplifier, the input impedance is high. This in turn enables the tuned circuit to be coupled to the base of the input stage with rather more turns than usual, which is equivalent to increasing the signal strength.

It should be noted that, in the case of a single-stage amplifier, the input impedance remains low even when a high-gain transistor is used. This effect is due to "Miller feedback"; i.e., voltage negative feedback from collector to base via the internal capacitance of the transistor. The higher the collector load, the lower the input impedance. In a two-stage r.f. amplifier like the present one, the Miller feedback in the second stage has the effect of presenting the collector of the first stage with a low-impedance load. This reduces the Miller feedback in the first stage and restores the input impedance to something like the no-feedback value. More turns can then be put on the coupling winding.

The use of "complementary cascade" circuitry (n.p.n. - p.n.p. - n.p.n.) enables the three transistors of the tuner section to be coupled directly, thereby saving a handful of coupling capacitors and bias resistors. D.C. negative feedback via the one bias resistor, R_2 , establishes the correct operating conditions for the complete tuner, and also provides a certain amount of a.g.c. action. (The collector potential of the detector transistor TR_3 falls when a station is tuned in. This reduces the bias of TR_1

and the resulting fall in collector current reduces the drop across R_1 , which causes the collector current of TR_2 to fall rather sharply.)

If desired, the gain of the r.f. amplifier can be increased by inserting an r.f. choke of around 1.5mH (not critical) in series with R_3 , the collector load resistance of TR_2 . This choke is shown in the diagram as L_3 . (If L_3 is omitted, the lower end of R_3 connects directly to the negative supply line.) The inclusion of L_3 also adds one possible way of introducing "reaction". If L_3 is anywhere near the ferrite rod there will be enough inductive coupling between the two to cause an appreciable amount of feedback between the output and input of the r.f. amplifier.

Resistors

(All fixed values $\frac{1}{4}$ watt 10%)

R_1	2.2kΩ
R_2	1.5MΩ
R_3	1kΩ
R_4	10kΩ
R_5	4.7kΩ
R_6	470Ω
R_7	10kΩ potentiometer, log track
R_8	100Ω (see text)
R_9	680Ω
R_{10}	330kΩ

Capacitors

C_1	See text
C_2	2.5μF electrolytic, 3V wkg.
C_3	125μF electrolytic, 3V wkg.
C_4	0.01μF
C_5	0.01μF
C_6	0.1μF
C_7	0.22μF
C_8	320μF electrolytic, 2.5V wkg.

Inductors

L_1, L_2	See text
L_3	Optional, type CH5 (Repanco)

Semiconductors

TR_1	BC168C
TR_2	GET693
TR_3	BC168B
TR_4	BC168C
* TR_5	2SD72
* TR_6	2SB405
D_1	Germanium bias diode

*Complementary matched pair.

Switch

S_1	s.p.s.t. on-off (may be ganged with R_7)
-------	---

Speaker

3 to 8Ω impedance

Miscellaneous

- 2 1.5-volt "pen-light" cells
- 1 Battery holder type BH2 (Eagle Products) or similar.

If this feedback is negative, sensitivity and selectivity are reduced. If the feedback is positive, sensitivity and selectivity are increased, very possibly to the extent that

(continued on page 166)

NEW WAFER-TYPE LOUDSPEAKERS

Oakland Trading Company announces the new unique Poly-Planar "Wafer-Type", wide-range, electro-dynamic speakers in a 5 watt model.

The unit is extremely thin, approximately one-fifth the depth of conventional cone speakers, but handling the same power range. This model P-5, equivalent to a 5-watt, 7in (17.78cm) speaker is only $\frac{1}{8}$ in (3.604cm) thick.

Poly-Planar units are made of expandable polystyrene plastic which make them lightweight and impervious to temperature extremes, humidity, shock, and vibration. The P-5 weighs only 11 ounces, is designed for any type of an acoustic enclosure in all commercial, industrial or military applications and can replace conventional cone speakers in high fidelity systems, in TV, radio or automotive installations, in public address systems and in marine applications. It can be used baffled, wall or cabinet-mounted.

The P-5 measures $\frac{1}{8}$ in x $4\frac{1}{2}$ in x $8\frac{1}{2}$ in. The new Poly-Planar catalogue is available from—Oakland Trading Co., 68, Lupus Street, London, S.W.1.

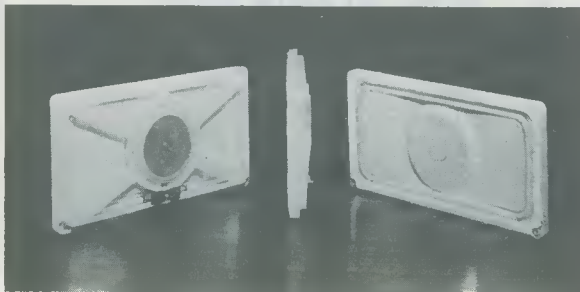

The new Poly-Planar electro-dynamic speakers

NEW 60 WATT SOLDERING IRON

With the introduction of the latest moulded nylon handle, the change-over to this type throughout the Litesold range of soldering instruments is complete. The new handle, which is similar in style to the smaller ones which have already proved so successful in service, is fitted to the 30, 35 and 60 watt models, the latter being an improved version of the 55 watt model, which it replaces.

Other improvements featured on the new 60 watt model are the change to spring-collet mounting of the bit and the simplification of the element fixing arrangement, which bring it into line with the other six Litesold models. There is also an increase in performance.

The new handle too is available in translucent nylon, so that we are now able to fit all instruments in the Litesold range with internal indicator lamps to show when the supply is switched on. This feature, which is supplied to order, can be valuable in reducing the risk of accidental burns and fires.



The new 'Litesold' soldering iron

UNIVERSITY OF THE AIR

Reporting in a BBC broadcast, Cecilia Page recalled that the conception of study by remote control is by no means new to Britain. For many years there have been flourishing correspondence colleges whose staff and pupils never meet, but who exchange written work and criticism through the post. For many years, too, the BBC has broadcast educational programmes on a wide variety of subjects. And the universities themselves have accepted many part-time students. But now, for the first time, all these elements are to be welded into an integrated whole, in order to help interested adults who somehow never collected the necessary paper qualifications to secure a place in a conventional university.

The "Open University", as it is sometimes called, demands no formal academic qualifications of its students; but standards are going to be high enough to ensure that when a degree is awarded, it will carry just as much weight as one from any other British university. Apart from administrative offices and broadcasting studios, the proposed university will have no tangible existence; tuition will be carried out largely through correspondence courses, backed up by BBC television and radio programmes. Students will be able to watch these—and closed-circuit television lectures from local colleges—in special viewing rooms all over Britain; and a lecturer will be on hand to lead discussion and add the personal touch.

Four years will be the normal minimum for an honours degree course—one year longer than in most British universities—and in order to qualify, the student will have to win credits in as many as eight subjects. Flexibility is to be the keynote: students will be encouraged to cross the conventional academic frontiers and choose their subjects from a very wide range.

The great advantage of the scheme is that it will not need the vast expenditure which is usually attendant on a new university. The initial capital cost is under a million pounds and it is estimated that running costs will amount only to three or four million pounds a year.

COMMENT

HI-FIRE

Fire is reproducing high-fidelity sound in a research project in the United States.

The flame from an acetylene welding torch is converting electrical signals received by it directly into music or speech.

"We were quite startled to hear the flame of the torch reproducing the sound from the tape recording," said one of the researchers on the project at the United Aircraft Corporation's Technology Centre at Sunnyvale, California.

"By using a flame, we have introduced the world's only omni-directional loudspeaker—sounds are emitted from the flame in all directions with equal force."

However, the researchers say that for a variety of technical reasons acetylene torches are not likely to replace conventional loudspeakers. Instead, the discovery may find other applications such as imposing sound pressure within a burning flame to cut the noise of jet engines.

The effects of sound on flames was first observed more than 100 years ago when it was noted during a concert that a gas flame jumped in time with certain notes from a cello. But apparently no one until now had discovered that flames can reproduce sound.

BUYER OR SELLER?

The sales and exchange facilities offered by magazines such as ours are always a popular feature with readers. The writer of this note must confess that it is one of the first items he peruses on purchasing a periodical.

The small advertisement feature in this magazine offers readers the opportunity of disposing of all that gear which has been cluttering up their shelves in their shacks and is unwanted surplus to them but to somebody else is just "what they wanted". The small ad. feature is excellent too for arranging exchanges of equipment and for seeking wanted items; it's surprising how often someone else has what you have been looking for.

If you want to have a good clear out in the shack don't just put the surplus in the dustbin; try a small advertisement and offer it at a reasonable price to another reader. Alternatively, if you are stuck for an old transformer, valve or other component, to get that old set of Grandma's going, an advert. will find it for you. If it has not occurred to you to use this useful feature in our magazine before—give it a try.

OCTOBER 1968

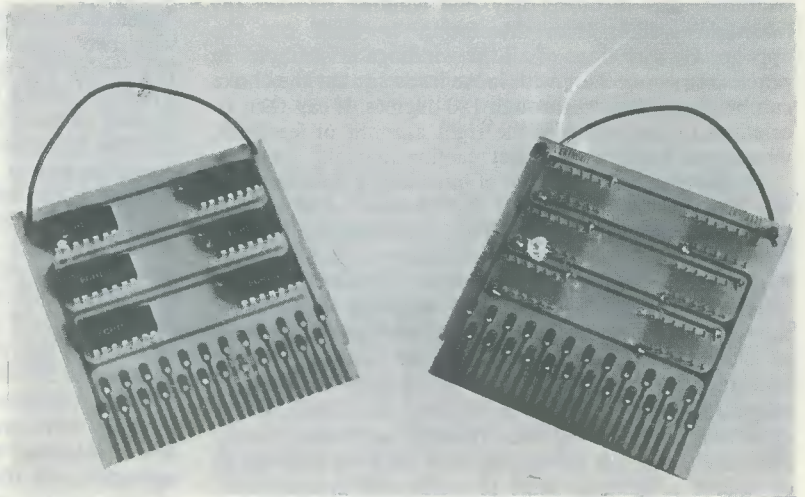

Picture shows (left) the face of the Cardiac 6 carrying 6 dual-in-line IC's and (right) the reverse side detailing the printed circuit

NEW IC MOUNTING BOARD FROM A.P.T.

A.P.T. Electronic Industries Ltd. have introduced a new type of integrated circuit mounting card, to mount up to 6 dual-in-line (14 or 16 lead) IC's.

Designated 'Cardiac 6, part number LK-3111, the new card is an addition to the company's well-known Lektrokit System.

This card, of copper-clad epoxy glass laminate, carries printed power supply tracks to each IC, and has 24 input/output edge-connector terminations at 0.1in/2.54mm pitch. Provision is made for the attachment of a nylon cord loop to assist card removal.

The Cardiac 6 is 2.7in/68mm square, and is priced at 7/6d. (£0.37½).

These cards are also available as part of a module kit assembly—Lektrokit No. 9—which includes the components for a complete mounting framework, with 6 sockets, guides and 6 'Cardiac 6' cards, at £5 15s. (£5.75) complete.

"For the last time. We are not calling him 'Micro Henry'!"

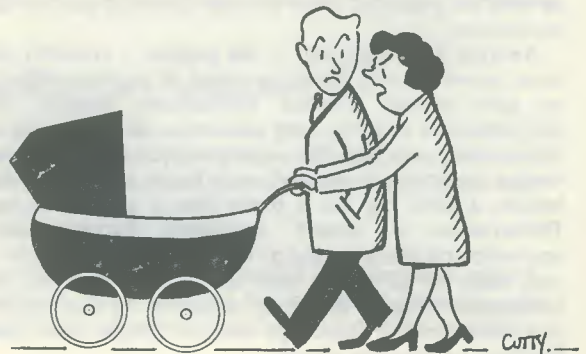

3-VOLT T.R.F. RECEIVER

(Continued from page 163)

the receiver oscillates. What governs whether the feedback is negative or positive is the relative direction of the windings, and reversing any one winding reverses the feedback. Rather than attempting to work out the appropriate directions of all the windings it is simpler in practice to connect L_3 with loose leads so that the choke can be twisted round through 180 degrees. It can then be oriented to produce just the right amount of feedback, whereupon it provides a preset reaction control.

An alternative simple way of introducing reaction does not require the presence of L_3 . Connect a short stiff insulated wire to the base of TR_1 , and bring the free end near R_3 . This causes capacitive coupling, and it is always in the correct direction to produce positive feedback, irrespective of the direction of the windings on the aerial rod. (This is, incidentally, another advantage of two-stage r.f. amplifiers.) If simply placing the wire near to or touching the body of R_3 is insufficient to produce oscillation, wrap it round R_3 two or three times. If this does not do the trick then there is something wrong somewhere (e.g. not enough turns on the base winding, or of course a genuine fault in wiring or components). Oscillation occurs first near the h.f. end of the medium wave band, and the "reaction probe" wire should be positioned so that oscillation just fails to occur when the battery is new.

The last two paragraphs assume that reaction is needed. In many cases performance will be adequate without it.

DECOUPLING AND FILTERING

One very important item in the general circuitry of the tuner section has not so far been mentioned. This is the decoupling and filtering. In the collector supply line, R_6 and C_3 prevent a.f. signals from the output stage getting back to the tuner circuit, where they could cause instability or distortion. At the same time, the RC low-pass filter formed by C_4 , R_5 , and C_5 removes r.f. signals from the a.f. output of the detector. These signals might otherwise get back to the input and cause h.f. oscillation, a fault very common in home-made receivers but apt to be puzzling to the constructor since it usually shows up as violent a.f. oscillation of the "motor-boating" variety. (The circuit becomes a squegging oscillator, the r.f. oscillations choking themselves periodically at an audio or very low frequency.) This type of oscillation is apt to be expensive as well as puzzling, since it often destroys one of the transistors.

Another important part of the receiver – probably the most important – is the ferrite aerial. It is rather difficult to give precise winding instructions because the characteristics of ferrite vary somewhat, as do the size of commercial rods and the capacitance of the associated tuning capacitor. In general, with ferrite aeriels as with boxers, a good big 'un is better than a good little 'un. Performance is always improved, barring some unpredictable effect caused by stray feedback, if the rod is well clear of all wiring and metal parts such as the loudspeaker magnet or tuning capacitor. As a guide, the rod aerial in the prototype was as follows (the data applying for medium waves):

$4\frac{1}{2}$ by $\frac{3}{8}$ in round rod, in Plessey NW25 ferrite.

Tuned winding: 60 turns, 5/46 s.w.g. Litz, close-wound.
Base winding: 10 turns of thin hookup wire, close-wound.

This rod was used with a 300pF Jackson "Dilemin" tuning capacitor. (Some further points concerning the ferrite aerial appear in the Note at the end of this article.— Editor.)

Before winding the aerial coils, the rod was wrapped with two turns of thin cardboard (the kind used for postcards). The use of a cardboard wrapping under the windings means that the coils have a former which is capable of being slid along the rod, and this is very useful for fine adjustment of the inductance. For long wave operation any of the conventional arrangements may be employed. The best is to have a long rod with the medium wave coil near one end and the long wave coil near the other, each with its own coupling winding. A two-pole two-position switch with one moving contact connected to the live side of the tuning capacitor and the other to the base of TR_1 , can then be used to switch the live sides of the appropriate coils into circuit. See Fig. 2. The presence of the long wave tuned winding on the rod, even when it is nominally switched out of circuit, affects the medium wave tuning. If the rod is too short (less than about 6in) it may be almost impossible to achieve two-band operation; the medium wave circuit will be pulled right off tune and the selectivity reduced. In this case it is better to dispense with full long wave coverage and settle for one long wave station only. Radio 2 on 200kc/s (1,500m) is the obvious choice in Britain. This can be tuned by switching a fixed additional capacitance across the medium wave coil after the latter has been satisfactorily set up for medium wave reception, the tuning capacitor being left in circuit to serve as a fine tuning control. The value of fixed capacitance required is approximately 7 times the maximum value of the medium wave tuning capacitance; in the case of a 300pF tuning capacitor the nearest standard value would be 2,200pF. A little experiment may be required to find the value which tunes the Radio 2 signal correctly. The additional fixed capacitor should be silver-mica, and not ceramic. A single-pole on-off switch is all that is required for switching the extra capacitance into circuit, as is shown in Fig. 3.

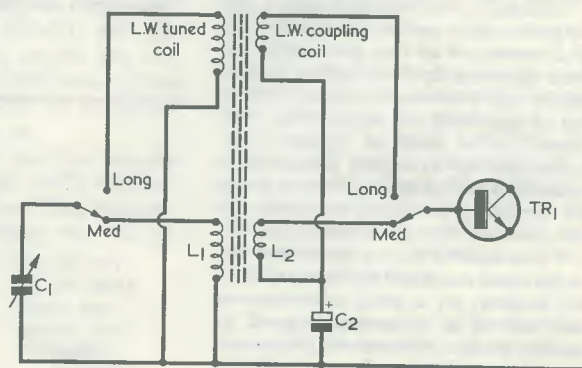

Fig. 2. If the ferrite rod is sufficiently long, tuned and coupling windings for long waves may be added. A double-pole double-throw switch is used for selecting wavebands.

AUDIO AMPLIFIER SECTION

The audio amplifier section is quite conventional and the only point that needs watching is the biasing of the output pair. Diode D_1 is a germanium junction diode, or a gold-bonded diode (not a point-contact type). These diodes have a forward voltage drop of around 250mV at low currents. This is slightly greater than the base-to-base voltage needed to bias the output pair into conduction ($I_c = 1\text{mA}$), and it is reduced by shunting the diode by R_g . Variations in diodes and transistors may dictate values in R_g slightly different from the nominal 100 Ω quoted in the Components List, if the quiescent current of the output pair is to be set at exactly 1mA. Too low a resistance causes crossover distortion, and too high an excessive quiescent current. The current may be checked by a meter in series with TR_6 collector.

The collector current of the driver has the rather low value of 2mA in this circuit because the output transistors are high-gain types (h_{FE} at least 100 at $I_c = 200\text{mA}$), requiring only a small base drive current from TR_4 .

Loudspeakers with impedances over 8 Ω may be connected, but the output power will be reduced. The amplifier consumes about 30mA during loud passages of pop music when the peaks are lightly clipped.

CONSTRUCTION

Construction presents no special problems. The prototype was made up in "pin-board" form; i.e., the components were soldered to anchorage points made by driving ordinary bright new domestic pins into a wooden baseboard and then cutting off the heads, leaving about $\frac{3}{8}$ in for use as solder tags.

Keep the r.f. wiring short and direct to reduce stray capacitance. Run the negative supply lead from the battery first to the collector of TR_6 and then to the tuner section. This reduces the risk of instability from stray coupling in the "earth" lead, a common fault in power amplifiers of this type where the large circulating currents in the output stage can set up appreciable voltages even across a few inches of plain wire.

It is a good idea to mount the ferrite rod, speaker, tuning capacitor, volume control, and any switches on a front panel, which can be made of Formica or other insulating board.

As a final point, this circuit is a variation on a design which has been in use in various parts of the world for some years now and it has proved to be simple to construct and reliable in use.

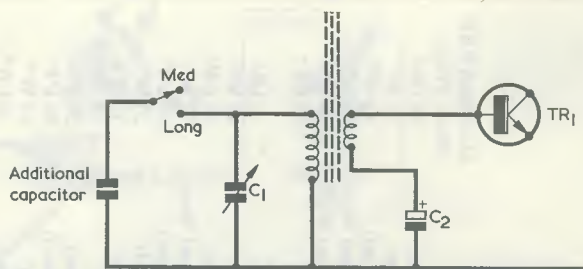



Fig. 3. With this simpler approach, the switch connects an additional capacitor across the tuned circuit for pre-tuned reception of Radio 2 on 1,500 metres.

EDITOR'S NOTE

As stated in the article, the number of turns on the ferrite rod depend on rod dimensions and ferrite grade. Any of the ferrite rods offered through home-constructor retail channels will be satisfactory here and it would be best to start with the medium wave band, using the 60 turns recommended by the author and reducing these if necessary until the desired medium wave coverage is obtained. Modern Litz wire is normally of the solder-through type and the soldering iron can be applied directly to the enamelled strands without previous stripping. A tuning capacitor, either air-spaced or with "Dilemin" insulation, of 300 or 310pF maximum capacitance will be satisfactory. The medium wave coupling winding (the author used hookup wire) can be of 20 to 16 s.w.g. in thickness. For maximum coupling it should be wound over the earthy end of the tuned winding, the end connecting to C_2 being over the end of the tuned winding connecting to the negative supply rail.

In general, the long wave tuned winding will require slightly less than 4 times the number of turns needed for medium waves. A suitable wire for both tuned and coupling windings on long waves is 36 s.w.g. double rayon covered enamelled copper, or similar. The tuned coil may be wound in a single pie, with the coupling winding close alongside. Again, it will be found easiest to wind on a few too many turns, then take these off until the desired range is achieved.

The coupling winding, on both medium and long waves, should have about one-sixth of the turns in the tuned winding.

A range of Litz wires, including 5/46, is available from Home Radio (Components) Ltd. 

LOW NOISE F.E.T. ANNOUNCED BY MULLARD

Latest addition to the Mullard range of f.e.t.'s is an n-channel depletion-type, silicon planar, epitaxial device intended for applications where circuit design calls for minimum noise and low intermodulation distortion. Type 2N3823, it has a 2.5dB spot noise figure of 100Mc/s.

Applications where the characteristically high input impedance, low noise figure and low feedback capacitance of the 2N3823 will give particular advantages include pre-amplifiers for radiation detectors and capacitance microphones, r.f. amplifiers, low-drift d.c. amplifiers and wide-band oscilloscope pre-amplifiers.

VHF RADIO TRANSMITTING STATIONS

Station	Radio 2, Radio 3, Radio 4				Maximum ERP (Each Prog.)
	Radio 2	Radio 3	Radio 4	Frequencies (Mc/s)	
North Hessary Tor	88-1	90-3	92-5		
Oban	88-9	91-1	93-3		
Orkehampton	88-7	90-9	93-1		
Orkney	89-3	91-5	93-7		
Oxford	89-5	91-7	93-9		
Penifler	89-5	91-7	93-9		
Perth	89-3	91-5	93-7		
Peterborough	90-1	92-3	94-5		
Pitlochry	89-2	91-4	93-6		
Pontop Pike	88-5	90-7	92-9		
Redruth	89-7	91-9	94-1		
Rosemarkie	89-6	91-8	94-0		
Rowridge	88-5	90-7	92-9		
Sandale	88-1	90-3	92-5		
Scarborough	89-9	92-1	94-3		
Sheffield	89-9	92-1	94-3		
Skraig	88-5	90-7	92-9		
Sutton Coldfield	88-3	90-5 ^s	92-7		
† Swaledale					
Swingate	90-0	92-4 ^s	94-4		
Tacolneston	89-7	91-9	94-1		
Thrumster	90-1	92-3	94-5		
Toward	88-5	90-7	92-9		
Ventnor	89-4	91-6	93-8		
Weardale	89-7	91-9	94-1		
† Wensleydale	88-3	90-5	92-7		
Wenvoe	89-9 ^s	96-8	94-3		
† Whitby	89-6	91-8	94-0		
Wrotham	89-1	91-3 ^s	93-5		
<i>BBC Local Radio Stations</i>					
Brighton	88-1				
Durham	96-8				
Leeds	94-6				
Leicester	95-05				
Merseyside	95-85				
Nottingham	94-8				
Sheffield	88-6				
(Rotherham)	95-05				
Stoke-on-Trent	94-9				
Includes stereophonic programmes					
† Station not in service at date of issue of this sheet; where frequencies or ERP are not shown, these are not finalised.					
* Directional Aerial					
<i>(Courtesy B.B.C.)</i>					



EXISTING STATIONS:- MAIN RELAY LOCAL
 LOW POWER RELAY STATIONS PLANNED OR UNDER CONSTRUCTION
 AREA COVERED





Cover Feature

BANDSPREAD H.F. BANDS SUPERHET

by
F. G. RAYER G3OGR

Intended specifically for the short wave listener, this sensitive superhet design offers loudspeaker reproduction from 6.5 to 32Mc/s, thereby including all the more popular broadcast frequencies as well as the amateur bands from 10 to 40 metres. The use of air-cored coils and a panel aerial trimmer obviates alignment difficulties, and ensures also that the aerial tuned circuit is always on peak.

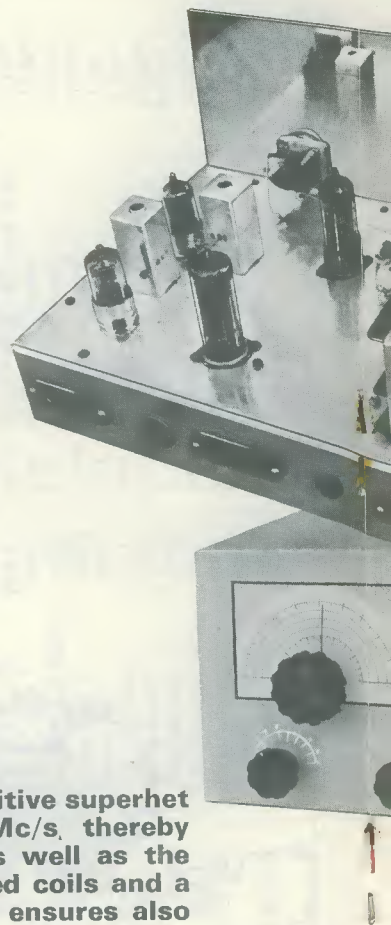

FOR SOME TIME CONDITIONS HAVE ALLOWED EXCELLENT long distance reception on the higher frequency short wave bands, and this is likely to continue for some years. The receiver described here covers approximately 6.5 to 32 Mc/s, in two switched bands. This includes all the more popular short wave broadcast frequencies, and also the 10, 15, 20 and 40 metre amateur bands.

THE CIRCUIT

Fig. 1 gives the circuit, and a few points should be mentioned. L_1 and L_2 are the aerial coils, and L_3 and L_4 the oscillator coils. Trimmers TC_1 and TC_2 are across the tuned windings of L_1 and L_3 , for the 14 to 6.5 Mc/s range. The second range is 32 to 10.5 Mc/s, oscillator trimming being by TC_3 . VC_3 allows the aerial circuit to be peaked up on either band, whilst VC_4 is the oscillator bandspread capacitor. A 2-gang bandspread capacitor is unnecessary, because the coverage of VC_4 is very small, and VC_3 enables the aerial coils to be trimmed for any setting of VC_4 .

The coils listed are in the Wearite P-coil range. These are made to precise standards and are of fixed inductance, so no cores have to be adjusted. Difficulty may be encountered in obtaining the coils through some retailers, but they are readily available from Home Radio (Components) Ltd.

C_5 is the lower frequency oscillator padder. The higher frequency range needs no oscillator padder because the frequency difference falls within the trimming range. This method of operation has been found very satisfactory, and VC_4 is extremely useful for exact tuning and searching in a narrow band of frequencies.

V_1 is the frequency changer, and V_2 the intermediate frequency amplifier. Automatic volume control bias is provided through R_6 .

As it is often found convenient to have an audio amplifier available for record playing or other uses, a Gram/Radio switch, S_2 , is fitted. This disconnects the screen grid and oscillator h.t. supply to V_1 and V_2 , and transfers the audio gain control VR_1 to the pick-up

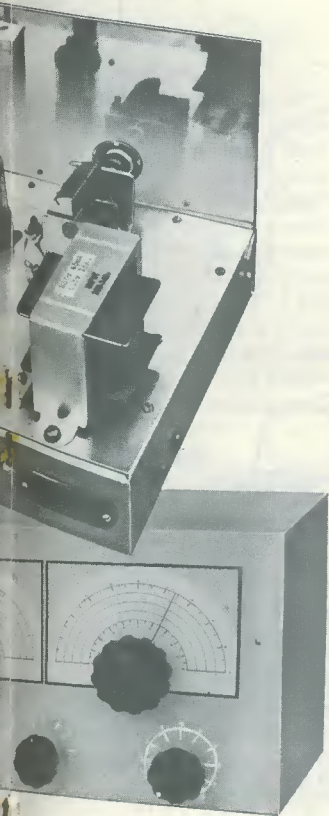

socket. V_3 and V_4 act as audio amplifier and output stage, giving ample volume from pick-up or radio. (A crystal pick-up is recommended.)

There is some simplification in the power-supply circuit, with h.t. being obtained from a contact cooled rectifier. The h.t. provided at C_{11} is 240 volts at 45mA, and is reduced by R_9 to 190 volts for V_4 screen-grid and earlier stages. (The peak h.t. reached before heaters gain operating temperature is about 335 volts.)

Though output is easily sufficient for a loudspeaker, phones are sometimes of advantage. These can be plugged directly into the sockets provided for the loudspeaker. This means there is an impedance mismatch, but it can be ignored in these circumstances. V_4 is able to deliver much more power than is required for phones. The phones may be of any impedance (or resistance) up to 2,000 Ω or so.*

METALWORK

Fig. 2 shows dimensions for marking out the chassis. A chassis punch is probably most suitable for the valvholder holes: $\frac{3}{4}$ in in diameter for V_1 and V_4 , and $\frac{5}{8}$ in for V_2 and V_3 . Valvholder orientation should be as illustrated in Fig. 3.

Holes for the i.f. transformers can be located correctly by holding the data slip supplied on the chassis, and marking through it with a sharply pointed tool. Pins must be in the positions shown in Fig. 3, and clear of the metal.

A $\frac{3}{8}$ in hole is drilled or punched each side of T_2 , so that primary and secondary leads can pass through.

*It would be preferable to ensure that the secondary of T_1 is always loaded by a speaker or a similar impedance as, otherwise, excessively high a.f. voltages can be developed across its primary. To avoid this, a resistor of some 3 to 6 Ω could be connected externally across the output sockets in parallel with the headphones when the latter are used.—Editor.

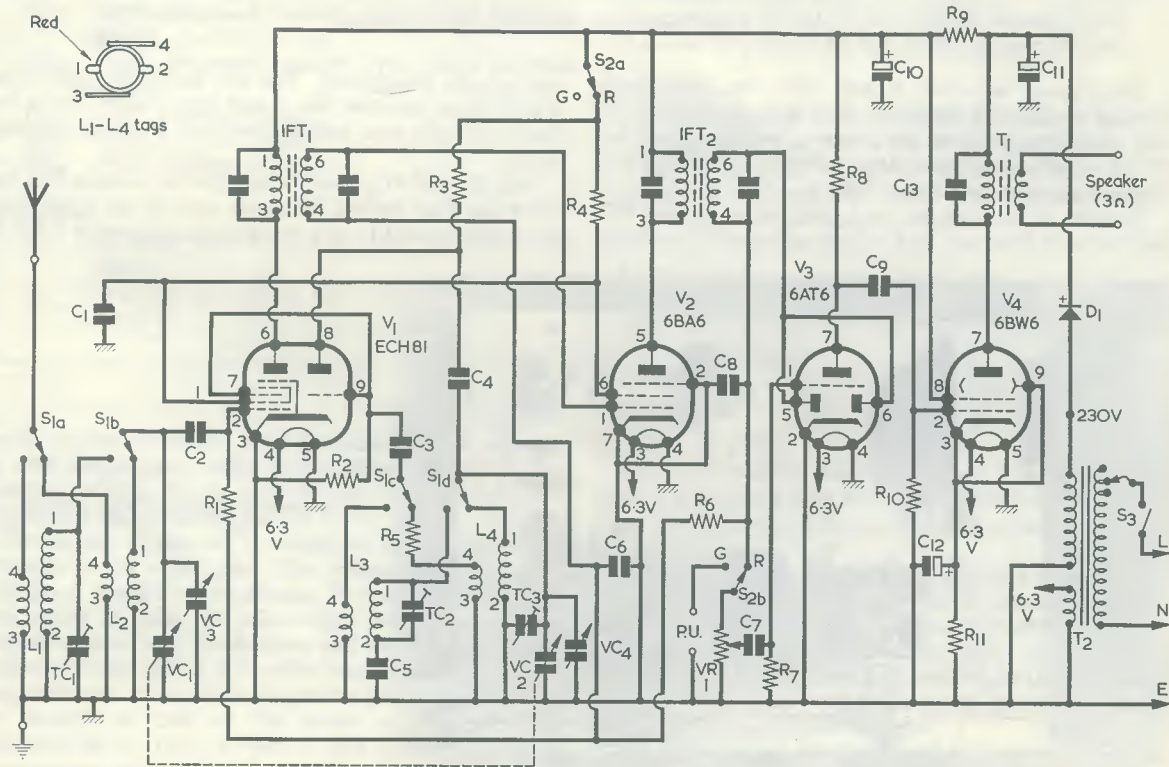

Fig. 1. The circuit of the Bandspeed H.F. Bands Superhet.

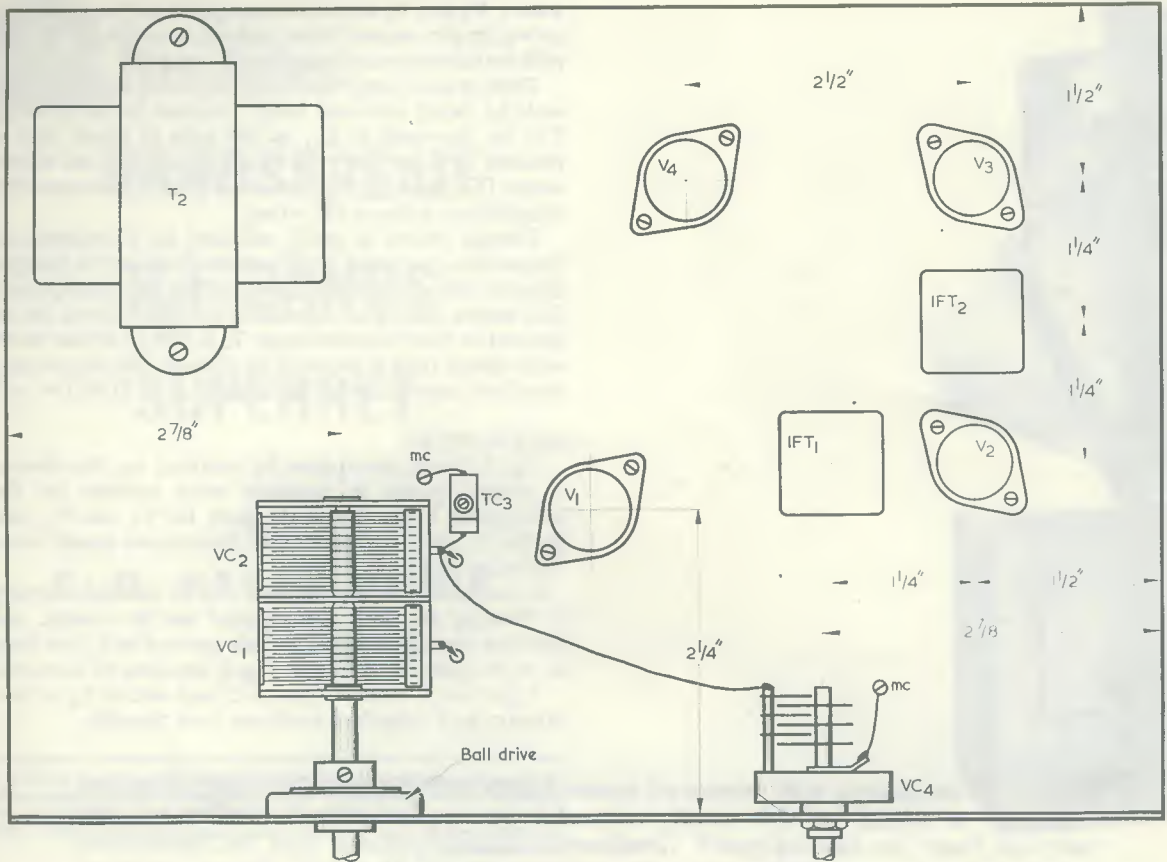

Fig. 2. Components and wiring above the chassis.

The 2-gang capacitor is held with two 4BA bolts. Spacing washers are needed on each bolt, between chassis and capacitor, so that the ceramic insulators are not forced against the chassis. Also, note that long bolts may touch or damage the fixed plates.

Pointers, or cursors, for the 2-gang capacitor and VC₄ may be made from stiff wire affixed to the ball drive

and spindle respectively. The two scales are taken from Panel Signs transfers Set 5 and they impart, for a low outlay, a very neat and professional finish to the front panel.

VR₁, S₁ and VC₃ hold the panel to the chassis. The ball drive lies flush behind the panel, and its lug is bolted to the panel. L₂ and L₃ are positioned as shown in Fig. 3 to

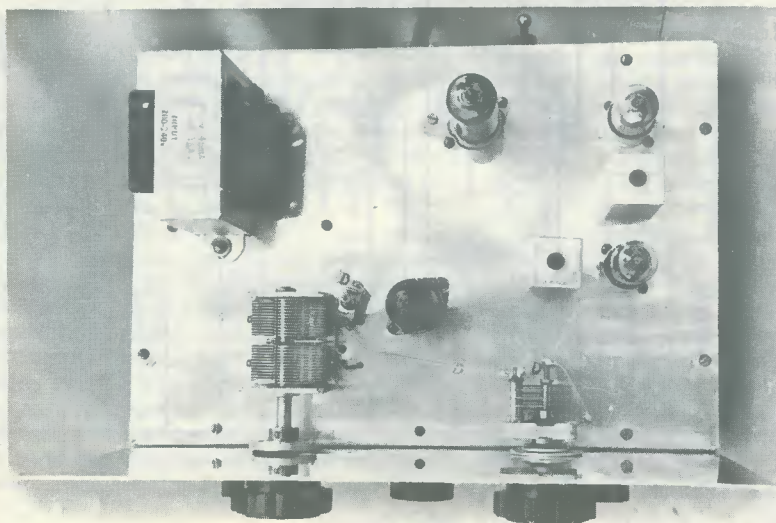

Top view of the completed chassis.

COMPONENTS

Resistors

(All fixed values 10%)

R ₁	1MΩ ¼ watt
R ₂	47kΩ ¼ watt
R ₃	33kΩ 1 watt
R ₄	22kΩ 1 watt
R ₅	100Ω ¼ watt
R ₆	1MΩ ¼ watt
R ₇	8.2MΩ ¼ watt
R ₈	270kΩ ½ watt
R ₉	2.7kΩ 1 watt
R ₁₀	470kΩ ¼ watt
R ₁₁	270Ω 1 watt
VR ₁	500kΩ potentiometer, log with switch S ₃

Capacitors

C ₁	0.1μF 350V wkg.
C ₂	100pF silver-mica
C ₃	47pF silver-mica
C ₄	200pF silver-mica
C ₅	5,000pF silver-mica
C ₆	0.1μF 150V wkg.
C ₇	0.01μF 150V wkg.
C ₈	200pF silver-mica
C ₉	0.01 350V wkg.
C ₁₀	32μF electrolytic, wire ended, 350V wkg.
C ₁₁	32μF electrolytic, wire ended, 350V wkg.
C ₁₂	25μF electrolytic, 25V wkg.
C ₁₃	0.01μF 350V wkg.
VC _{1,2}	365 + 365pF 2-gang variable, Cat. No. VC2 (Home Radio)
VC ₃	50pF air-spaced variable, type C.804 (Jackson Bros.)
VC ₄	15pF air-spaced variable, type C.804 (Jackson Bros.)
TC ₁	60pF, trimmer, mica
TC ₂	60pF, trimmer, mica
TC ₃	30pF, trimmer, mica

Inductors

L ₁	Wearite type PA3, Cat. No. C083C (Home Radio)
L ₂	Wearite type PA4, Cat. No. C083D (Home Radio)

L ₃	Wearite type P03, Cat. No. C085C (Home Radio)
L ₄	Wearite type P04, Cat. No. C085D (Home Radio)
I.F.T. ₁	I.F. transformer type IFT.11/465 (Denco)
I.F.T. ₂	I.F. transformer type IFT.11/465 (Denco)
T ₁	Speaker transformer, 5,000:3:75Ω, Cat. No. T043 (Home Radio)
T ₂	Mains transformer, secondaries 230V 45mA, 6:3V 1:5A, Cat. No. TM26A (Home Radio)

Valves

V ₁	ECH81
V ₂	6BA6
V ₃	6AT6
V ₄	6BW6

Rectifier

D ₁	Contact cooled, half-wave, 250V 50mA
----------------	--------------------------------------

Switches

S ₁	4-pole 2-way rotary
S ₂	2-pole 2-way toggle
S ₃	s.p.s.t., part of VR ₁

Sockets

2 B7G	valveholders, with centre spigots
2 B9A	valveholders, with centre spigots
1 socket strip (A.E.)	Cat. No. Z101A (Home Radio)
1 socket strip (PU)	Cat. No. Z101B (Home Radio)
1 socket strip (LS)	Cat. No. Z101C (Home Radio)

Miscellaneous

1	epicyclic tuning drive, type 4511/F (Jackson Bros.)
3	knobs, small, Cat. No. KN6 (Home Radio)
2	knobs, 'rge, Cat. No. KN77 (Home Radio)
2	scales, from Panel-Signs Set 5 (Data Publications)
2	3-way (centre earthed) tagstrips
	Chassis, 7 x 10 x 2in
	Panel 7 x 10in
	3-core flexible mains lead
	Grommets, solder tags, wire, etc.

avoid absorption effects. They are secured to the chassis by 6BA countersunk bolts before fitting the panel. The positions of holes for the sockets, gram-radio switch, and mains lead can be taken from Fig. 3.

Grommets should be provided at all chassis holes through which wires pass. The points marked "MC" indicate a connection to chassis. In most cases, chassis connection is made at solder tags secured under the mounting nuts for valveholders and other components, as is made clear in Fig. 3. In other cases, single solder tags may be bolted to chassis at the points indicated. It should be possible to drill all the holes required after an examination of Figs. 2 and 3, and before mounting components and commencing wiring.

OCTOBER 1968

POWER SUPPLY

The mains lead is 3-core flexible cord. This can be taken to a 13 amp mains plug, fitted with a 2 amp fuse. At the plug, connect green to Earth (E), black to neutral (N) and red to fuse (L).

At the receiver, the lead passes through a grommet and is anchored at a tagstrip, as in Fig. 3. Green connects to chassis, whilst black and one primary lead from T₂ join at a tag. A lead from the red core passes to S₃ on VR₁, the second switch tag being connected to the remaining primary lead. These wires run along inside the chassis against the front and side member.

It is important to ensure that all these connections are correctly made and, in particular, that the chassis connects,

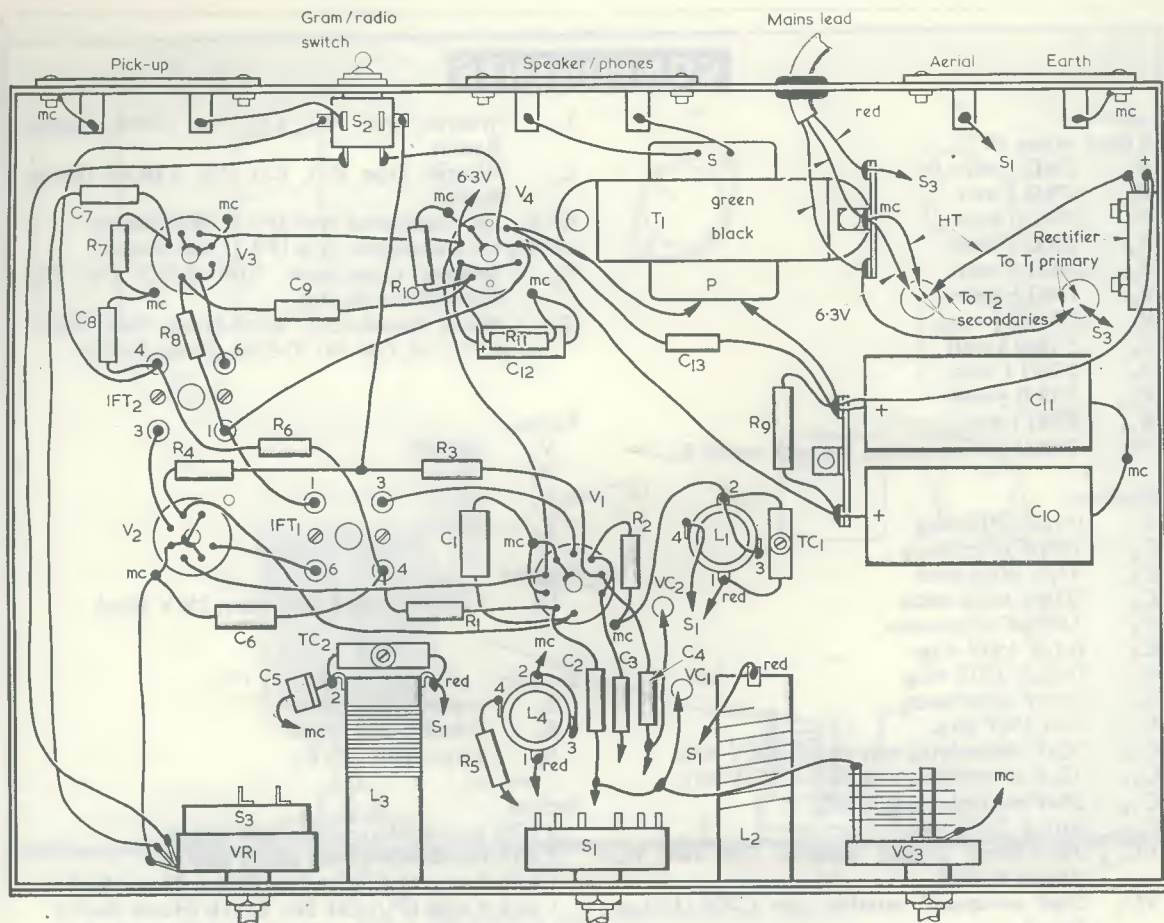

Fig. 3. The below-chassis layout and wiring.

mc—chassis connection

via the green mains lead, to mains earth. The primary connection to T_2 is made to the tap corresponding to the local mains voltage. If this transformer has lead-out wires instead of tags, the unused primary tap leads must be adequately taped up and folded out of the way to ensure that they cannot short-circuit to chassis or to any other connection.

T_2 heater winding is connected to chassis, as are all valve heaters. Note that tag 4 of V_3 valveholder should connect to chassis, as shown, to avoid hum.

The contact cooled rectifier must be wired in with correct polarity. It is bolted to the side of the chassis,

which provides the requisite cooling. A good thermal contact is needed here and there should be no burrs on the chassis holes to prevent this.

AUDIO STAGES

It is not necessary to screen the leads to VR_1 , as they are run along the side of the chassis, well away from other circuits (Fig. 3). The centre tag of the three shown on VR_1 is the slider, and connects to C_7 . The tag connecting to chassis is that at the minimum volume end of the track.

The gram-radio switch transfers the volume control, VR_1 , from the pick-up socket to pin 4 of I.F.T.₂, and the wiring is shown in detail in Fig. 4. The second pole breaks the h.t. supply to R_3 and R_4 , for "gram" operation.

Note that C_{12} negative lead-out is taken to chassis. If wished, audio and power circuits can be checked by connecting a pick-up and speaker. Take the pick-up lead outer brading to the chassis socket. Output is controlled by VR_1 , and results should be good, with plenty of volume.

BANDSWITCH

This is fitted as shown in Fig. 3, and wired as in Fig. 5. Coils L_2 and L_3 are positioned as in Fig. 3, as previously described, whilst Fig. 5 illustrates them as seen from the top or tagged ends, so that the connections may be shown more clearly.

Trimmers TC_1 and TC_2 are on short, stout leads, wired directly across the coil tags. Wires from the switch to

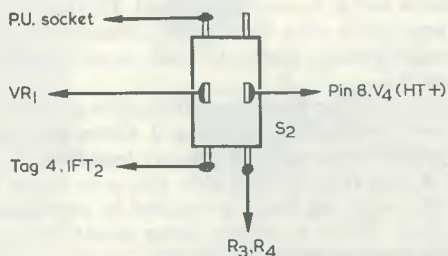
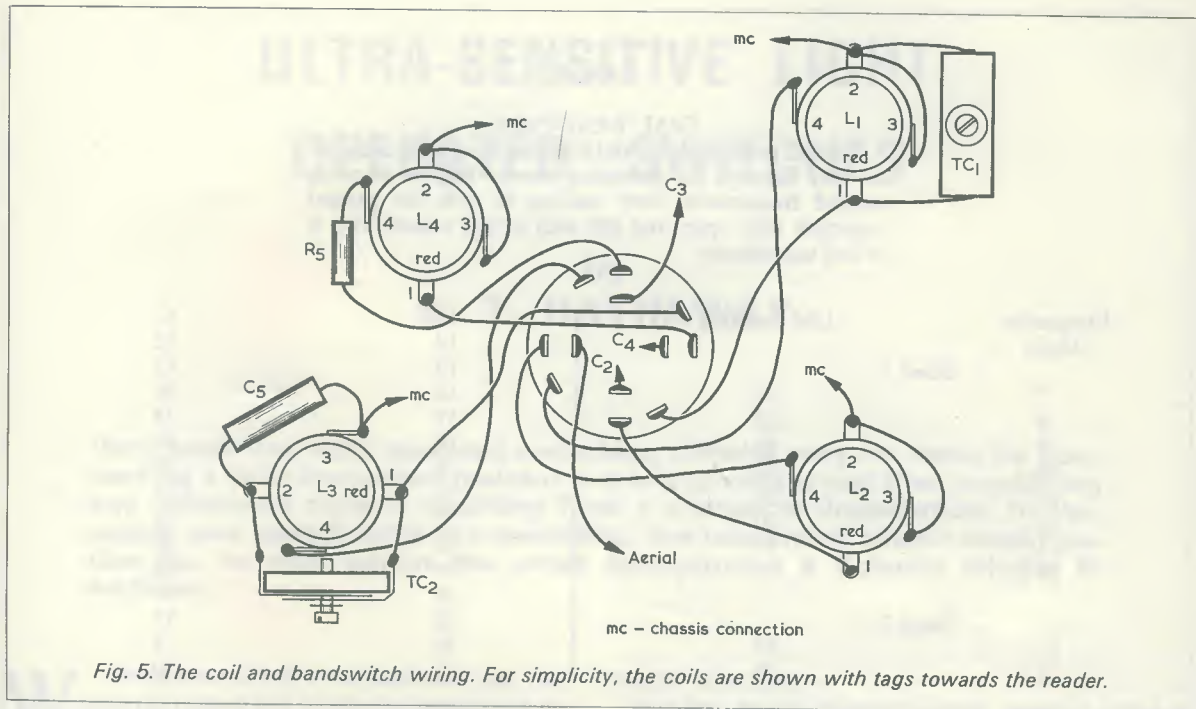

Fig. 4. Detail showing the connections to the gram/radio switch S_2 .



VC_1/VC_2 , C_2 , C_3 and C_4 , and to L_2 and L_4 are as short and direct as possible. So are earth returns from the coils to chassis.

L_1 and L_3 are in circuit for the lower frequency band, and L_2 and L_4 for the higher frequency band. Switching is quite straightforward. But, if preferred, L_1 and L_3 only can be connected initially to the switch, and the receiver then tested. If all is well, L_2 and L_4 can next be wired up.

COIL TRIMMING

Initially set TC_1 and TC_2 nearly closed, and TC_3 almost open. Minimum capacitance is low on the higher frequency range, and this is why the specified coils reach 32 Mc/s.

It should be possible to peak VC_3 for best reception throughout each band. If VC_3 has to be completely open (at minimum capacitance) on the higher frequency range,

OTHER CIRCUITS

The i.f. amplifier and other circuits should present no difficulty. TC_3 is connected directly from VC_2 to chassis (Fig. 2). All r.f. wiring, such as that from VC_2 to VC_4 , and from coils to switch, etc., is clear of the chassis. On the other hand, h.t., heater and audio circuit leads are best run close to the chassis surface.

I.F. ALIGNMENT

As the i.f. transformer cores are approximately tuned at the factory, unnecessary readjustment of them is not recommended. However, when the receiver is found to operate normally, the cores can be touched up for best results, using a correctly shaped and insulated tool. A weak signal is best for alignment purposes, and can be obtained by using a short piece of wire as aerial.

Should a signal generator be available, then it can be employed in the usual way, alignment being at or near 465 kc/s.

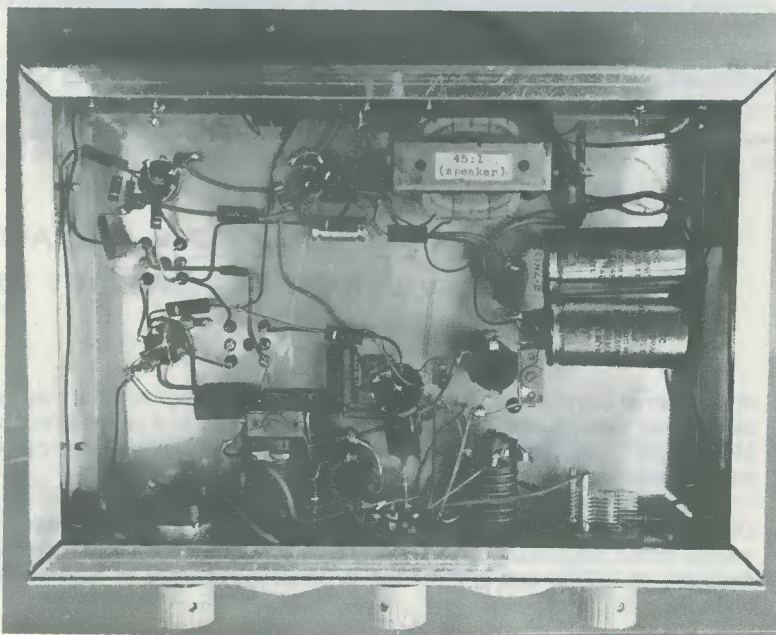

The components and wiring below the chassis. (Different knobs were fitted when this photograph was taken).

TABLE

DIAL READINGS

Though exact readings and frequencies must be expected to vary slightly, the following should help in locating wanted frequencies. Zero reading is with the ganged capacitor fully open, and 100 with it fully closed. VC₄ is at half capacitance.

Frequency (Mc/s)	Dial Reading		
	<i>Band 1</i>		
7	90	13	61
8	62	14	52
9	48	15	45
10	34	16	39
11	26	17	35
12	20	18	31
13	15	19	28
14	9	20	25
		21	22
		22	20
		24	16
		26	13
	<i>Band 2</i>	28	11
11	83	30	5
12	70	32	0

screw down TC₃ slightly. Should VC₃ need to be fully open on the lower frequency band, screw down TC₂, or open TC₁, to correct this.

As the coil inductances are matched during manufacture, VC₃ will allow correct aerial trimming. On the higher frequencies, rotating VC₃ may cause some oscillator pulling. The pulling is slight, and can be minimised by avoiding unnecessary stray capacitance or coupling between aerial and oscillator circuits. This may be done by keeping aerial tuned circuit leads clear of those in the oscillator circuit.

Exact frequency coverage naturally depends on trimming and other factors, but the list of frequencies and dial readings in the accompanying Table should allow wanted bands to be found fairly easily.

Trimming and normal tunings are carried out with VC₄ at half capacitance. Adjacent near frequencies can then be covered with VC₄, and this facility is particularly convenient in the amateur or broadcast bands.



**INTERNATIONAL COMPUTERS LTD. AWARDS MULLARD
CONTRACT FOR MEMORY STACKS**

International Computers Ltd. has awarded Mullard a substantial contract to supply matrix core stocks for the data stores used in the 4-70 computer in its System 4 range. This, with a similar contract announced in March 1967, has given Mullard a major part of the total business placed by I.C.L. for stacks required for the 4-70 computer during the next two years.

Designed for the main working stores of the 4-70 computer, each stack has a capacity of 4096 36-bit words. More than 50 million ferrite cores will be used in fulfilling the contract. Each core has an outside diameter of 2,020" and is threaded by three wires used to read information into and out of the computer memory.

The stacks will be made by the Industrial Assemblies Division of Mullard's Mitchum, Surrey, factory, which manufactures cores, matrix stacks and complete memory systems for many leading computer firms and for special government projects.

ULTRA-SENSITIVE LIGHT OPERATED SWITCHES

by
B. T. HATHAWAY

Very sensitive light operated switching circuits may be made by connecting a light dependent resistor in a bridge circuit and then amplifying any unbalance current resulting from a change in illumination. In this article two switch units are described, one employing simple amplification on its own whilst the other incorporates a Schmitt trigger in addition.

WHEN DESIGNING THE TWO LIGHT SWITCHES THAT form the basis of this article, the primary aim was to produce units which were sufficiently sensitive to give positive operation of a relay as a result of the minute changes in light level caused by a mere puff of cigarette smoke, and to do so with the minimum of circuit complexity and cost. These aims have been achieved with considerable success, and of the two units designed the first uses only 4 resistors and 2 transistors whilst the second uses 8 resistors and 4 transistors, both units employing a single relay and a 2-battery supply system. The second of the two units has a sensitivity about twice that of the basic version.

Because of the exceptionally high degree of sensitivity achieved with these switches, they are ideally suited for use as smoke or fire detectors, and as fog, rain, or ice detectors, etc., as well as for the more conventional applications, such as automatic house light operators.

BASIC CIRCUIT

The first step in designing a light operated switch is to select a suitable light sensor and here two types are readily available, these being either the phototransistor or the cadmium-sulphide photocell. Unfortunately, the characteristics of the phototransistor are subject to change with temperature variations, so that this type of device is not suitable where ultra-high sensitivity is required with good reliability. This leaves us with the cadmium-sulphide photocell; otherwise described as a light-dependent resistor (l.d.r.) in which, typically, the resistance will vary from some 100Ω under conditions of extreme brightness to greater than 1MΩ under conditions of absolute darkness. This type of device is subject to very little resistance change with variations in temperature, and is thus suitable for use in the applications that we have in mind.

A sensitive circuit for detecting small changes in

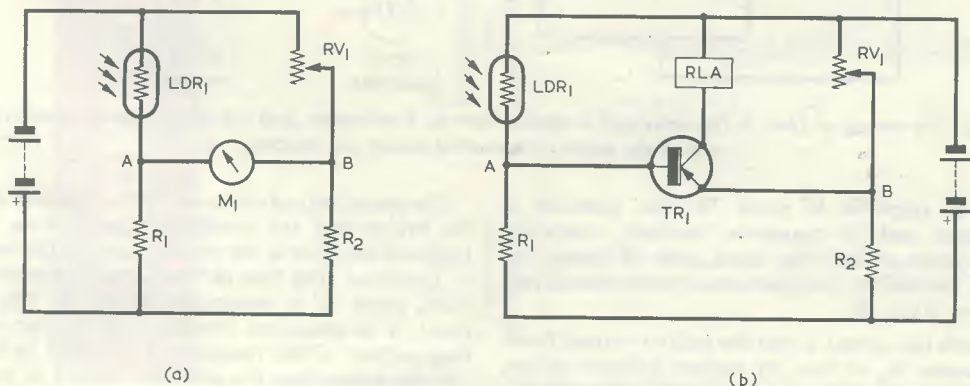

Fig. 1 (a). Basic Wheatstone bridge
(b). One possible way of using the bridge circuit with an l.d.r.

COMPONENTS

Resistors

(All fixed values $\frac{1}{4}$ watt 10%)

R ₁	1k Ω
R ₂	1k Ω
R ₃	6.8k Ω
RV ₁	5k Ω skeleton pre-set potentiometer

Transistors

TR ₁	OC75
TR ₂	AC128

Light Dependent Resistor

LDR₁ ORP12

Relay

RLA 120 Ω or greater, 6-8V operating (see text)

Switch

S_{1(a)(b)} d.p.s.t. on-off

Batteries

B ₁	6V battery
B ₂	12V battery

Miscellaneous

Veroboard, 0.15 in matrix, 2 x 1 $\frac{1}{2}$ in, see Fig. 3
Wire, battery connectors, etc.

resistance is the Wheatstone bridge, shown in practical form (with an l.d.r.) in Fig. 1(a). Here, the l.d.r. and R₁ are wired as a potential divider, with junction 'A', and RV₁ and R₂ are wired as a second voltage divider, with junction 'B'. Both the voltage divider chains are fed from a common supply, and a moving coil meter, M₁, is connected between points 'A' and 'B'. If RV₁ is now adjusted so that the potential at point 'B' is exactly equal to that at point 'A', zero current flows through meter M₁ and the bridge is said to be balanced.

If the value of the l.d.r. is now changed by even the smallest amount, due to a small change in the light level, the potential at point 'A' will change and the bridge will go out of balance, whereupon a current will flow through meter M₁. Using the supply polarity shown, if the value of the l.d.r. reduces, this current will flow from 'B' to 'A', or, if the value of l.d.r. increases, the current will flow from 'A' to 'B'. (Conventional current, flowing from positive to negative, is assumed here.) Quite clearly, if a diode is wired in series with M₁, the meter will be made to give an indication only when the bridge moves out of balance in one particular direction, i.e., either when the light increases, or when the light reduces.

It should be noted that the actual balance point of the bridge is independent of the supply voltage or polarity.

Having found a satisfactory method of detecting very small changes in light level, the problem now is to make the 'out of balance' currents operate a relay via suitable transistor circuitry. One system which might conceivably be employed is shown in Fig. 1(b). Here, the emitter-base junction of TR₁ is effectively used as a diode, so that when

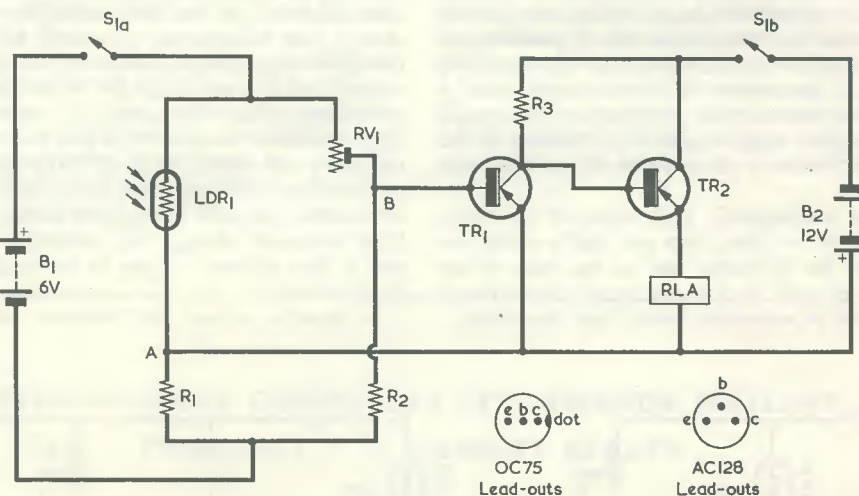

Fig. 2. The circuit of Unit 1. The relay coil is shown here as a rectangle, and the relay contacts, which connect to the external controlled circuit, are omitted.

point 'A' is negative of point 'B' the junction is forward-biased and the transistor conducts, operating relay RLA. When, on the other hand, point 'B' is negative of point 'A', the emitter-base junction is reverse-biased and the transistor is cut off.

A snag with this circuit is that the emitter current flows through resistor R₂ so that, by emitter follower action, the voltage at point 'B' tends to follow that at point 'A', and, although the circuit does work reasonably well, the sensitivity is not particularly good.

The easiest way of overcoming this difficulty is to supply the bridge and the transistor circuits from their own batteries, and this is the system used on the two units to be described. The first of these units is shown in Fig. 2. Here, point 'B' is connected directly to TR₁ base and point 'A' is connected directly to the emitter, so that the base current of this transistor is provided by battery B₁. At the same time, the collector current is provided by B₂, and no trouble is experienced through emitter follower

(continued on page 181)

RADIO CONSTRUCTORS DATA SHEET

15

RC/DS/15

WINDING

TEMPERATURE
TABLE

Resistance increase (%)	Temperature above ambient (°C)	Resistance increase (%)	Temperature above ambient (°C)
1	3	21	54
2	5	22	56
3	8	23	59
4	10	24	62
5	13	25	64
6	15	26	67
7	18	27	69
8	21	28	72
9	23	29	74
10	26	30	77
11	28	31	79
12	31	32	82
13	33	33	84
14	36	34	87
15	38	35	90
16	41	36	92
17	44	37	95
18	46	38	97
19	49	39	100
20	51	40	103

To find the winding operating temperature of power inductors wound with copper wire (e.g. mains transformers, TV line output transformers and deflector coils, etc.) measure winding resistance cold then repeat after the component has reached operating temperature. The Table gives winding temperature above ambient for percentage increase in resistance. (Temperature coefficient of annealed copper = 0.0039).

Example. In an ambient temperature of 18°C, the resistance of a winding increases from 20Ω cold to 24Ω hot (= 20% rise). Winding operating temperature is 18°C plus 51°C = 69°C.

TRADE NEWS

PLESSEY WINDFINDING RADARS

An order for two Type WF2 Windfinding Radars has been placed with Plessey Radar Limited, a member of the Plessey Electronics Group, by the Italian Ministry of Defence. The equipment—valued at over £40,000—will be used for the determination of upper winds.

The WF2 is a 3 cm (X band) radar with manual tracking, able to track a balloon-borne target to a distance of approximately 120 miles.

Meteorological services in many parts of the world are using Plessey WF2 windfinding radars. During the past 12 months the equipment has been supplied for use in Iran, Faroe Islands, Antarctica, Germany and Pakistan.

FERRANTI ANNOUNCE NEW STROBOSCOPIC FLASH TUBES

The Electronic Display Department of Ferranti Ltd., Gem Mill, Oldham, Lancs., have announced a new range of stroboscopic flash tubes, the ED70 series. This series is similar to the existing ED60 series, except for an operating voltage of 400 volts instead of 500 volts. Tubes in both series give an intense white light and are suitable for a wide range of applications. Their circuit requirements are very simple, and in many applications they can replace existing red light sources. They are particularly suitable for use in engine timing lights, for which application they can be triggered directly from the ignition.

The ED60 and ED70 series tubes are inexpensive and reliable, and give an average life of more than 20 million flashes.

NEW ELECTRONIC THERMOMETER

Comark Electronics Limited are introducing an entirely new range of electronic thermometers which are simple to use, reliable and accurate in operation, compact and attractively styled.

The first of these new instruments, electronic thermometer type 1601, gives direct readings of temperature from -87°C to $+1000^{\circ}\text{C}$, using any chromel/alumel thermocouple.

No adjustments are required; the thermocouple (of any length) is connected to the instrument, a suitable range is selected, and temperature is indicated directly on a robust meter with 5 in. scale length. The four ranges of the instrument are -87°C . to $+25^{\circ}\text{C}$. 0 to 100°C . 0 to 300°C . and 0 to 1000°C ; accuracy is $\pm 2^{\circ} + 1^{\circ}\text{C}$.

A d.c. output, proportional to reading, of 1 volt at full-scale (max. current 2mA) is provided to drive a recorder or a DVM. Models are available with single input or 12-way selector switch.

The 1601 is powered by dry cells, with a.c. power unit option in laboratory or rack mounting models (when a temperature trip relay may be specified). The case is a robust plastic moulding with photo-etched front panel. A leather carrying case is available.

Further details may be obtained from Gage Publications and Design, 174 Frog Grove Lane, Wood Street, Guildford, Surrey. Telephone: Normandy 2141.

EMI COLOUR CAMERAS

EMI Electronics have received orders from the BBC for 68 type 2001 colour cameras—the camera which won for EMI this year's Queen's Award to Industry. The order which includes supplementary zoom lens packages and other ancillary equipment is worth approximately £1.4 millions.

One of Britain's brightest export prospects, the type 2001 rapidly won the acceptance of British broadcasting organisations leading to orders worth over £3 millions for the camera and ancillary equipment since its introduction last year. Its many unique features, including the integral zoom lens and the "capstan" arrangement of the pick-up tubes, were factors which resulted in the presentation of the Queen's Award for technological innovation.

With the BBC order to supply cameras for the Television Centre and Lime Grove studios as well as 15 cameras for outside broadcasts, the EMI colour camera now dominates the London television area. ABC Television, which was combined with Rediffusion to form Thames Television, has ordered fourteen. The only other London-based company, London Weekend, recently ordered 22 EMI colour cameras, after stringent evaluation tests of all available equipment.

MARCONI "DIAL-A-COMPUTER"

An advanced data communications system which enables computers to communicate internationally over normal switched telephone lines, and makes it possible for data to be fed into a computer in another country, or even on another continent, was recently shown in operation on the Marconi stand at the British Engineering Exhibition in Copenhagen. The system, known as Marconidata, enables data to be transferred directly into a computer at any point which can be reached by telephone. Errors due to noise and interference are virtually eliminated by the system, which will detect and correct all but about 1 in 10 million, equivalent to transmitting the entire works of Shakespeare twice, with only one letter in error.

This system operated on the Marconi stand between two telephone terminals, with a simulated 'noisy' telephone line to demonstrate this important feature. The demonstration used paper tape inputs and outputs, with an associated teletypewriter.

ULTRA-SENSITIVE LIGHT OPERATED SWITCHES

(continued from page 178)

action. Very high sensitivity is thus obtained.

To enable a wide range of relay types to be used, the supply is fed to the relay via an emitter follower, TR₂. It should be noted that the polarity of the supply to the bridge circuit is now reversed compared to Figs. 1(a) and 1(b).

The circuit of Fig. 2 functions in the following manner. RV₁ is adjusted so that under normal lighting conditions TR₁ is drawing a current such that its collector is at about 2 volts negative of its emitter, and RLA, in the emitter circuit of TR₂, is de-energised. If the light level now falls by a small amount, the resistance of the l.d.r. will increase and the voltage at point 'A' will become more negative, reducing the base current of TR₁. The collector current of TR₁ will also fall, making the collector voltage more negative and increasing the voltage across relay RLA, which will then energise. Once the light returns to its

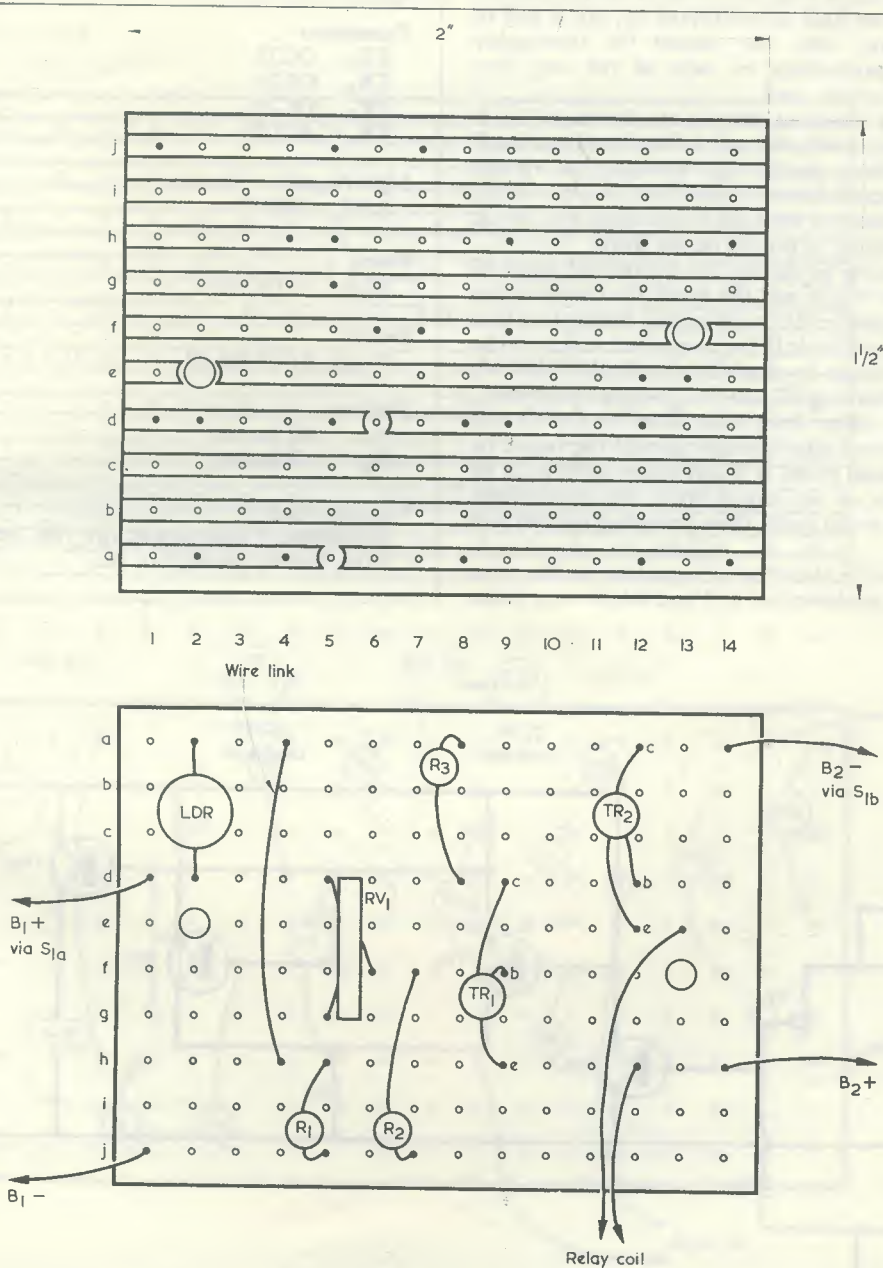

Fig. 3. Copper and component sides of the Veroboard panel for Unit 1. The on/off switch, S₁ (a) (b), is mounted externally

normal level, the relay will de-energise again.

UNIT 1

This particular circuit, which we shall refer to as Unit 1, gives outstandingly good results, the only snag being that the relay itself has rather wide on/off voltage ratio, so that a fairly large voltage swing is required to give positive relay operation. Typically, a relay may need 8 volts connected across it before it will energise, but will not de-energise again until this potential is reduced to 2 volts, giving an On/Off ratio of 4:1 and indicating the need for a swing of greater than 6 volts for positive operation of the relay.

In spite of this minor snag, the circuit gives very positive operation when the light is interrupted by, say, a puff of cigarette smoke, and the circuit is thoroughly recommended, particularly in view of the very few electronic components used.

Constructional details of the unit are shown in Fig. 3. For ease of construction, the unit is wired up on a small piece of Veroboard panel, thus retaining all of the advantages of printed circuit construction, while involving none of the problems of marking out, etching, etc., which are normally involved in printed circuit work.

Start construction by cutting the Veroboard panel to size, as shown in Fig. 3, and then break the copper strips with the aid of a small drill or the special cutting tool that is available, as indicated. If the completed unit is to be mounted to a chassis or small sub-panel, drill the two small mounting holes, at E2 and F13, to clear 6BA screws. Clean back the copper from these holes on the E3 and F12 sides to prevent short-circuits, should the board be mounted on a metal panel. It is convenient to fit p.v.c. or rubber grommets on the screws under the board when fitting, later, to a metal panel, these providing spacing and insulation.

Now assemble the electronic components on the plain side of the panel, as shown in Fig. 3, and solder them to the

COMPONENTS

Resistors

(All fixed values $\frac{1}{4}$ watt 10%)

R ₁	1k Ω
R ₂	1k Ω
R ₃	6.8k Ω
R ₄	3.9k Ω
R ₅	470 Ω
R ₆	33k Ω
R ₇	3.9k Ω
RV ₁	5k Ω skeleton pre-set potentiometer

Transistors

TR ₁	OC75
TR ₂	OC75
TR ₃	OC75
TR ₄	AC128

Light Dependent Resistor

LDR₁ ORP12

Relay

RLA As for Fig. 2

Switch

S_{1(a)(b)} d.p.s.t. on-off

Batteries

B ₁	6V battery
B ₂	12V battery

Miscellaneous

Veroboard, 0.15in matrix, $2\frac{7}{8} \times 1\frac{1}{2}$ in, see Fig. 5
Wire, battery connectors, etc.

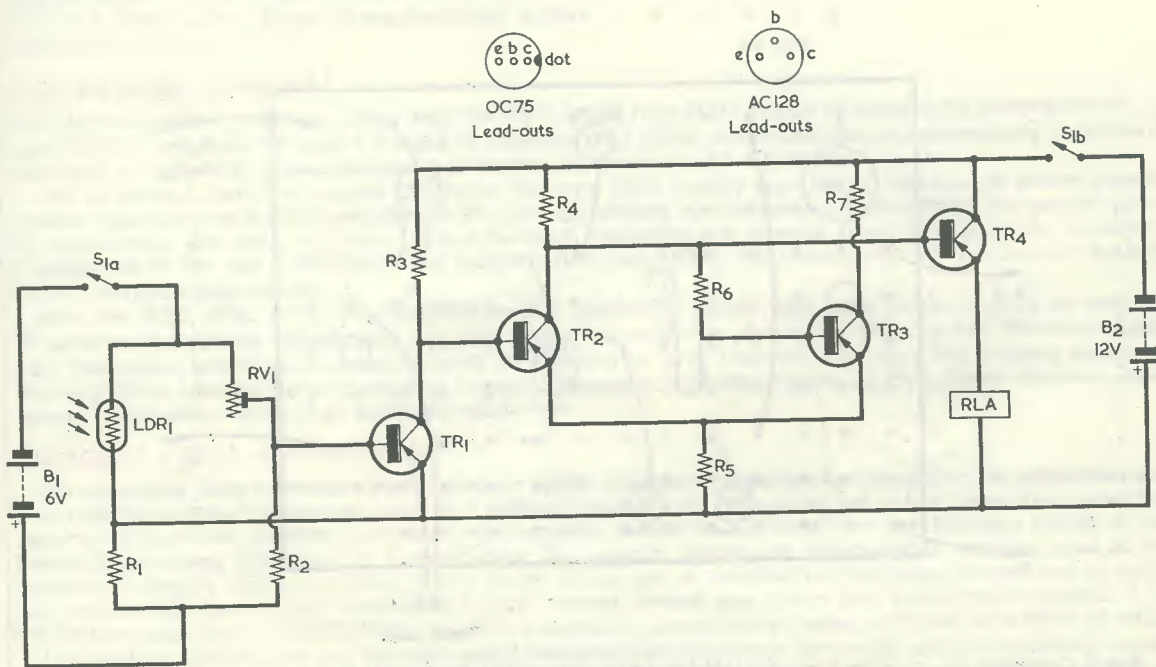

Fig. 4. The circuit of Unit 2.

copper strips. The legs of RV_1 will require reducing in width by means of a small file so that they are capable of passing through the holes in the Veroboard. When construction is complete, a suitable relay should be connected in place. This relay should have a coil resistance of 120Ω or greater, and should operate at a potential of 6 to 8 volts. On the prototype, a relay with a coil resistance of 670Ω was used.

(A number of relays are available on the home constructor market meeting the author's specification. An

inexpensive example is the S.T.C. miniature relay available from Electronics under Code No. 11301H. This has a coil resistance of 140Ω , nominal energising voltage and current of 6V at 42mA, and one set of changeover contacts rated at 50V 0.3A.—Editor).

Next, connect the two batteries to the unit, switch on and check the functional operation of the device. Note that the unit is designed to operate at light levels approximating to normal room lighting. Adjust RV_1 so that RLA operates, and then re-adjust RV_1 so that the relay just de-energises

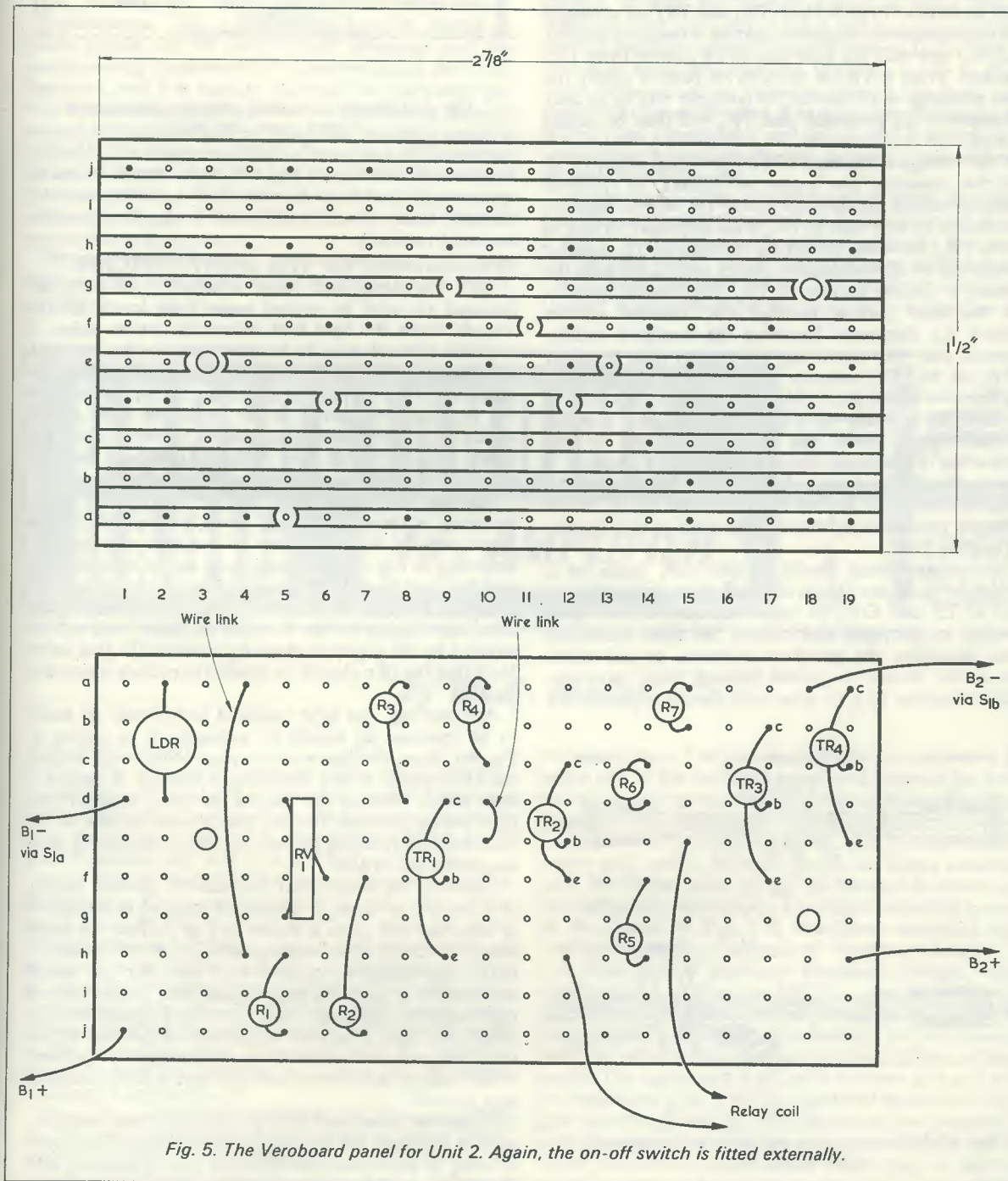

Fig. 5. The Veroboard panel for Unit 2. Again, the on-off switch is fitted externally.

again; now reduce the light level by a very small amount, either by casting a shadow across the l.d.r. or blowing smoke across its surface, and check that the relay energises. If satisfactory, the unit is now complete and ready for use.

UNIT 2

It has been pointed out that the only shortcoming with Unit 1 is that a swing of approximately 6 volts is needed to cause RLA to operate, resulting in a slight loss in sensitivity. This difficulty can be overcome by interposing a Schmitt trigger between the transistor amplifier and the relay, as shown in Fig. 4. Here, TR₂ and TR₃ are arranged as common emitter amplifiers sharing a common emitter load, R₅, and with the base bias of TR₃ taken from TR₂ collector. Thus, if TR₂ is off, with its base at nearly the same potential as its emitter, its collector will be at near full negative rail potential, and TR₃ will thus be biased hard on.

If the voltage at the base of TR₂ now goes negative, so that this transistor just begins to conduct, its collector potential will fall and the base bias to TR₃ will be reduced. The change in base bias to TR₃ is an amplified version of that to TR₂, however, so that the decrease in TR₃ emitter current will be of considerably greater magnitude than the increase of emitter current to TR₂. The overall result is that the total current through the common emitter resistor, R₅, decreases, lowering the common emitter potential and thus increasing the emitter-base potential of TR₂, so that TR₂ collector current is further increased. Regenerative action takes place, and TR₂ switches sharply on and TR₃ switches off. Thus, it can be seen that the Schmitt trigger circuit has its state changed by the application of a suitable direct voltage to TR₂ base.

Note that the polarity of the supply voltage to the bridge circuit in Fig. 4 is the reverse of that in Fig. 2. The setting up procedure is, however, the same as that already outlined for Unit 1.

Full constructional details of this unit, again on a Veroboard panel, are shown in Fig. 5. Note that mounting holes at E3 and G18, to clear 6BA screws, are again provided in the panel and require the same treatment. When mounting the panel to a chassis or sub-panel, 6BA screws should be passed through these mounting holes and rubber or p.v.c. grommets should be interposed

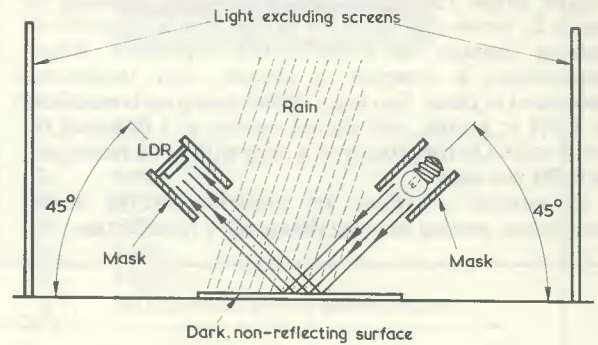

Fig. 7. Operation by light reflected from water (rain), snow, ice, etc.

between the Veroboard and the main chassis to act as spacers and insulators. As with Unit 1, the legs of RV₁ will need to be reduced in width. All the fixed resistors are mounted vertically.

APPLICATIONS OF THE LIGHT SWITCHES

With the component values specified, both units are designed to work at normal room light levels, and to 'switch' when the light falls below the pre-set value. If required, the units may be made to operate when the light rises above the pre-set value by simply reversing the polarities of the supplies to the bridge circuits. Because of the very high sensitivity of the units, the light source should be maintained at a reasonable constant level, and direct lighting to the face of the l.d.r. should be used whenever possible.

The fact that the switches may be operated by either increases or decreases in light levels, as required, makes them suitable for a number of unusual applications. Referring to Fig. 6(a), for example, it can be seen that the switches may be used as smoke operated units by simply directing the light from a lamp on to the face of the l.d.r., and relying on the fact that the light level will be reduced by the presence of smoke between the two units. Note that the l.d.r. should be masked to exclude unwanted lighting.

Alternatively, the light operated switch may be made to be operated by smoke by arranging it as shown in Fig. 4(b). Here, the light source is placed at an angle behind the l.d.r., which is thus normally in shadow. If smoke is now blown towards the face of the l.d.r., however, the light will be reflected from the smoke onto the face of the l.d.r., and the resulting increase in light level may be used to operate the switch.

Similarly, the switch may be made to operate by fog, or even rain or snow. A preferable method of operation in these last two cases is shown in Fig. 7. Here, the lamp beam is directed downwards at an angle of 45° towards a dark, non-reflective surface, and the l.d.r. is aimed downwards at the same angle to the same surface, but at right angles to the lamp. Thus, if the dark surface were to reflect, the light reflection would fall on the face of the l.d.r. The complete assembly is surrounded by a screen, which will exclude direct sun-light but will not exclude rain or snow.

If rain or snow now falls on the dark, non-reflective surface, the light will be reflected from the resulting layer of water or snow, and will strike the face of the l.d.r., and the resulting increase in light level can be made to operate

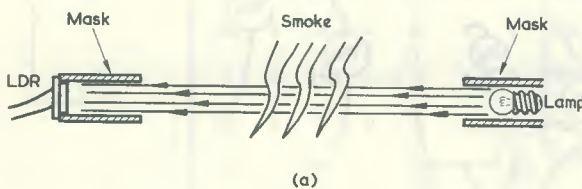

(a)

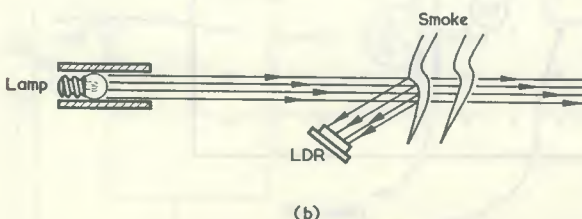

(b)

Fig. 6(a). Operation by decrease in illumination due to smoke.

(b). Operation by increase in light reflected by smoke.

the light switch. This circuit will also be operated by ice or frost.

Many other applications will, no doubt, occur to the reader. It will have been noted that, in Figs. 3 and 5, the l.d.r. is shown as being soldered directly to the Veroboard. This is a convenient method of mounting, particularly for

initial tests of the circuit in which it appears. If, for any application, it would be more convenient for the l.d.r. to be separate from the board it may be removed, being reconnected to its circuit points on the board by suitable lengths of wire.



IN LAST MONTH'S ISSUE WE CONTINUED OUR EXAMINATION of the superhet mixer by discussing conversion conductance. This is the relation between change in anode current at the intermediate frequency and the corresponding change in control grid voltage at the signal frequency, and it is usually expressed in microamps per volt. We saw also that it is possible to measure the grid current at the mixer grid to which the oscillator signal is applied by the simple expedient of inserting a milliammeter between the lower end of the grid resistor and chassis, and that manufacturers issue curves in the data for their mixer valves which show conversion conductance plotted against this grid current.

We now have a few final points concerning the mixer valve to deal with, after which we shall turn to the i.f. amplifier.

frequency is thus produced at the anode in the same manner as with the heptode mixer we have already discussed. The pentagrid of Fig. 1 has no suppressor grid and it is necessary to apply supply voltages to it which do not allow secondary emission from the anode to g5 to occur. This secondary emission effect is the same as is given with the tetrode valve. A later version of the pentagrid of Fig. 1 has a suppressor grid added, and is known as an *octode* since it has eight "useful electrodes" (the cathode, six grids and the anode).

An alternative class of pentagrid, of which the 6BE6 provides an example, functions in the basic circuit shown in Fig. 2. In this instance the cathode connects to a tap in the oscillator tuned coil, g1 functions as an oscillator grid and g2 as an oscillator anode. This oscillator circuit is a Hartley configuration of the type we examined in the

UNDERSTANDING RADIO

I.F. AMPLIFIER

$$f = \frac{1}{2\pi\sqrt{LC}}$$

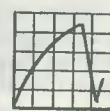



by W. G. Morley

THE PENTAGRIDS

A number of frequency changer valves, often described as *pentagrids* (because they have five grids), have been used successfully in long, medium and short wave receivers. Since the principles by which these valves operate are of general interest they will next be briefly described.

One type of pentagrid frequency changer circuit is illustrated in Fig. 1, and is employed with valves of the 6A8G class. It will be noted that grid g1 of the valve functions as an oscillator control grid whilst grid g2 functions as an oscillator anode. In the practical valve, g2 normally consists of two straight vertical wires only, these being quite sufficient to allow oscillation to occur without impeding, to any great extent, the flow of electrons to the succeeding grids. The third grid, g3, is joined internally to g5 and functions as a screen grid. The signal frequency is applied to g4.

The pentagrid of Fig. 1 provides mixing by reason of the fact that the electron flow from cathode to anode is first varied in amplitude by the oscillator grid g1 and then, to a lesser extent, by the signal frequency at g4. A difference

May 1966 issue. The padding capacitor is inserted at the upper end of the oscillator tuned coil, because the lower end of the coil has to connect direct to chassis in order to provide a d.c. circuit path for the cathode. As well as functioning as an oscillator anode, grid g2 acts also as a screen grid, and is followed by g3, the signal frequency grid. The further grids, g4 and g5, function as screen grid and suppressor respectively. A pentagrid intended to work in the circuit of Fig. 2 is sometimes described as a "self-oscillating" or "self-excited" frequency changer.

A third type of pentagrid frequency changer, which would employ a valve type DK96 or similar, is shown in Fig. 3. This differs from the two preceding circuits because the pentagrid is a battery valve having a 1.4 volt filament. With this valve, g1 is the oscillator grid and g2 the oscillator anode. The signal grid is g3, g4 is a screen grid and g5 is the suppressor grid. It will be noted that there is no screen grid between g2 and g3, with the result that a degree of capacitive coupling exists between the oscillator and the signal frequency tuned circuit. This type of valve is normally employed in medium and long wave portable

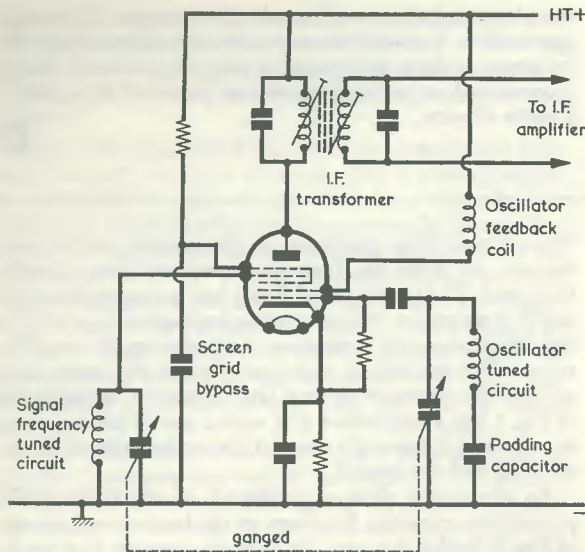

Fig. 1. A pentagrid frequency changer circuit incorporating a valve of the 6A8G class. Trimmers and padding adjustments (such as adjustable iron-dust cores) are omitted for simplicity

receivers having a ferrite rod aerial and so oscillator frequency radiation, and consequent interference with other receivers, is not so troublesome as would occur if a wire aerial were used. Also, oscillator power is low and the oscillator is of the tuned grid type with g2 connecting to the feedback winding, thereby providing greater isolation between signal frequency and oscillator tuned circuits than would occur if the oscillator tuned circuit coupled to g2 instead. To enable the oscillator to start more reliably at reduced h.t. voltages (caused by partly run-down batteries) the oscillator grid resistor is returned to the positive end of the filament rather than to the negative end.

All the valves of Figs. 1, 2 and 3 can be alternatively described as "heptodes", but the name "pentagrid" is much more frequently encountered for the valves of Figs. 1 and 2. The valve of Fig. 3 is more often referred to as a "heptode" but both terms have been employed for it.

ADDITIVE AND MULTIPLICATIVE MIXERS

In the first type of mixer we examined when introducing the subject of frequency changing, the signal and oscillator frequencies are applied to a single grid of the mixer valve. These frequencies are, in consequence, added together, and the resultant difference frequency results from their sum. It may be recalled that this was demonstrated (in the last April issue) by first drawing the signal and oscillator frequency waveforms over a number of cycles and then drawing the envelope of the waveform which resulted from their addition. Mixers of this type are known as *additive mixers*, the term applying to any signal distorting device intended to function as a mixer where both signal and oscillator frequencies are fed to a single input terminal.

When the signal and oscillator frequencies are applied to two separate grids in a single electron stream, as occurs with the ECH81 heptode or with the pentagrids we have just discussed, the resultant anode current at difference frequency varies as the *product* of the two input signals.

(It does not vary as the sum because the signals do not add; instead, one signal varies the mutual conductance offered by the valve to the other). Mixers of this type are referred to as *multiplicative mixers*.

Turning to another point, we have shown that any mixer produces an output frequency equal to the difference between the two input frequencies applied to it. What we have not yet mentioned is that it also produces an output frequency equal to their *sum*. To explain this point it will prove helpful to remember that the output of an amplitude modulated transmitter consists of its carrier frequency plus two sideband frequencies spaced away from it on either side by the modulating frequency. There is an analogy here with the mixer, and it could be said that the higher of the two input frequencies (call it f_1) applied to a mixer is at "carrier frequency", and that it is amplitude modulated by the lower of the two input frequencies (f_2). The output of the mixer will then consist of f_1 and two "sideband frequencies", these being $f_1 - f_2$ and $f_1 + f_2$. The first of these, $f_1 - f_2$, is already familiar to us as the difference frequency. The second "sideband frequency", $f_1 + f_2$, is that which is equal to the sum of the two input frequencies. The sum frequency is of no use to us in a superhet and the tuned circuits in the i.f. transformers which follow the mixer prevent it from being passed through the i.f. amplifier.

Also present at the anode of the mixer are, of course, the two input frequencies themselves, i.e. the signal and oscillator frequencies. These are also prevented, by the i.f. transformer tuned circuits, from passing through the i.f. amplifier.

THE I.F. AMPLIFIER

As we have already briefly mentioned (in the last May issue) the intermediate frequencies chosen for domestic long, medium and short wave receivers are in the range 450 to 475kc/s according to the design of the individual set. This choice of intermediate frequency has been found, with experience over the years, to offer the best compromise in terms of selectivity and sensitivity for receivers of this type. An important point here is that the intermediate frequency must not be equal, or close, to any of the signal

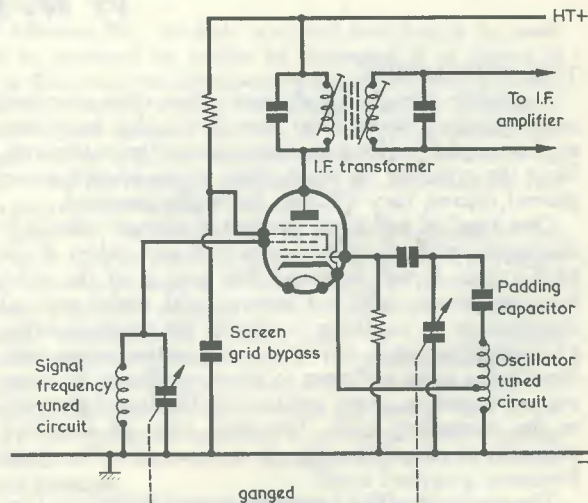

Fig. 2. Another pentagrid frequency changer circuit, sometimes referred to as "self-oscillating" or "self-excited"

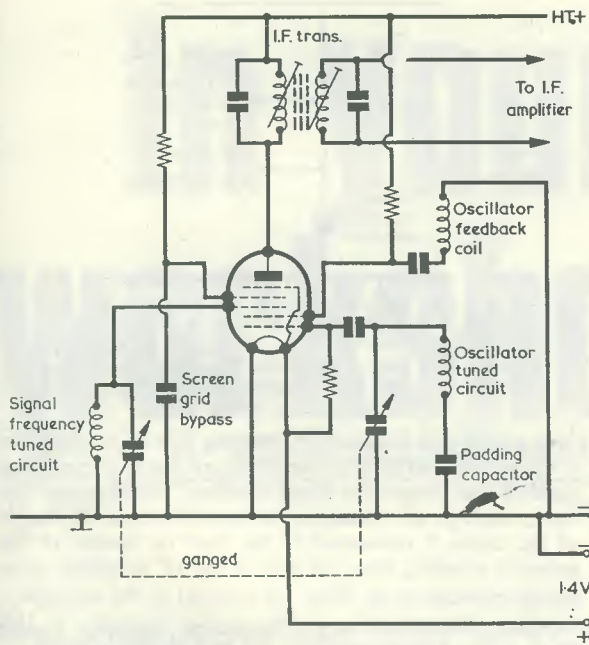
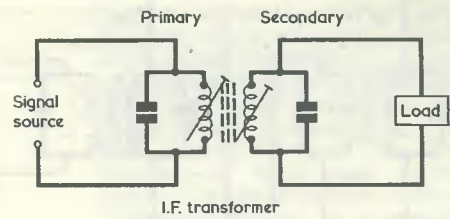

Fig. 3. Frequency changer circuit employing a battery valve. In this case the oscillator feedback coil is shunt-fed

frequencies it is intended to receive because this would result in instability and heterodynes due to the two frequencies beating together. Normal medium wave coverage is from some 1600 to 600kc/s and long wave coverage is from some 300 to 150kc/s, whereupon an i.f. lying between 450 and 475kc/s neatly avoids approaching the ends of either of these two bands.

The selection of the desired band of frequencies in the i.f. amplifier which follows the mixer of a superhet is carried out by tuned circuits in the i.f. transformers. We discussed i.f. transformers in considerable detail earlier in this series¹ and, although the issues concerned are now out of print, it would be wasteful of space to repeat the full detail here.² Suffice it to say that i.f. transformers of the type encountered in domestic valve sound receivers consist of two tuned circuits in a screening can inductively coupled together to provide, normally, what is described as *critical coupling*. The circuit symbol for an i.f. transformer having an adjustable iron dust core for the coil in each tuned circuit appears in Fig. 4(a). Fig. 4(b) shows the overall response from input to output which is given if the coils are *under-coupled* (i.e. the inductive coupling between them is less than critical), and it will be seen that it consists of a relatively sharp peak. Fig. 4(c) illustrates the result when the coils are *over-coupled*, and shows the double-peaked response typical of such coupling. It should be noted that the amplitude at the resonant frequency in the over-coupled curve is slightly less than at either of the two peaks. Critical coupling occurs when, as coupling between the coils is increased from the under-coupled state, the response at the resonant frequency just commences to decrease, and is illustrated in Fig. 4(d). It will be seen that the peak of the response is



(a)

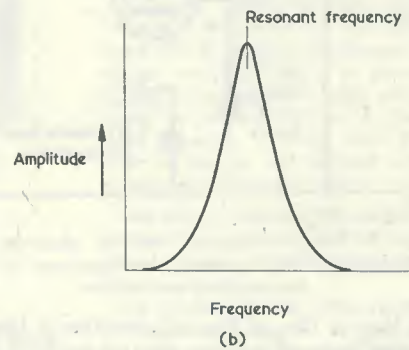

(b)

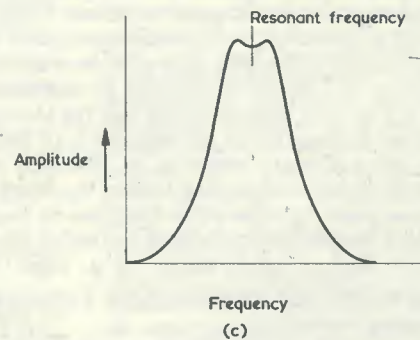

(c)

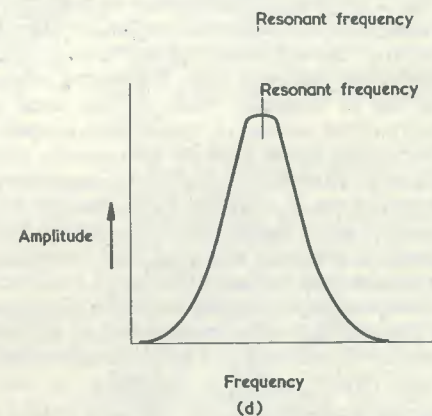

(d)

Fig. 4 (a). An i.f. transformer connected between a signal source and a load. The impedance presented by the load can vary the overall response curve of the transformer

(b). An under-coupled i.f. transformer produces the sharp single-peaked response shown here

(c). When over-coupled, the i.f. transformer produces a double-peaked response

(d). At critical coupling, the response just commences to approach the double-peak shape

¹In "Understanding Radio" in the November and December 1963 issues.

²Judging from correspondence, regular readers of *The Radio Constructor* make a point, in any case, of retaining all their copies!

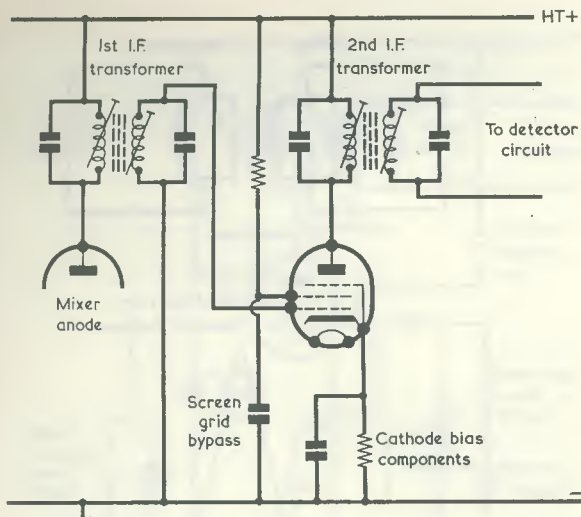

Fig. 5. Basic circuit of an i.f. amplifier, as encountered in domestic a.m. receivers. A.G.C. connections are omitted

broader than is that of Fig. 4(b) but that it has not yet commenced to break up into the two peaks of Fig. 4(c).

In standard domestic a.m. receivers, sufficient i.f. selectivity is given by two i.f. transformers, and sufficient gain by a single r.f. pentode connected between these. The basic circuit of a typical i.f. amplifier for such a receiver is shown in Fig. 5. In view of the fact that the i.f. amplifier of a superhet is required to provide much of the receiver gain, it may appear surprising to find that adequate results are given here by a single valve. However, it has to be remembered that this valve functions in conjunction with tuned circuits having a high Q and which are designed to offer optimum performance at a single band of frequencies only; and the circuit of Fig. 5 is quite adequate for domestic receivers.

In Fig. 5 the first i.f. transformer appears between the mixer and the i.f. amplifier valve. The load (see Fig. 4(a)) presented to the secondary of the first i.f. transformer consists of the relatively high impedance offered at the grid of the i.f. amplifier valve. At the same time, the secondary of the second i.f. transformer couples into the detector circuit. As we shall see next month, the detector circuit presents a somewhat lower impedance than does the grid circuit of the i.f. amplifier valve. Because of this, it is a common practice for the inductive coupling between the two tuned circuits in the second i.f. transformer to be made a little tighter than occurs in the first i.f. transformer. The reason for the tighter coupling is that the effective coupling factor between the coils becomes less as the impedance presented to the secondary of an i.f. transformer decreases, and the tighter inductive coupling in the second transformer enables it to offer the same critical coupling response as does the first.

A point not immediately obvious from Fig. 5 is that

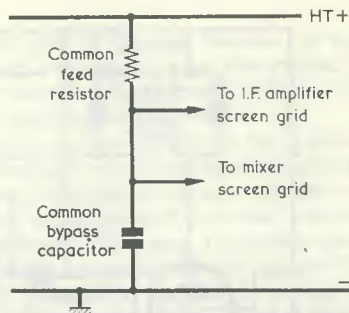

Fig. 6. It is a common practice in domestic a.m. receivers to connect the screen grids of both the mixer and the i.f. amplifier together, supplying these by way of a common feed resistor and bypass capacitor.

best results will be obtained from the first i.f. transformer if the anode and grid connections are made to opposing ends of their respective tuned windings. If, assuming that both windings are wound in the same direction, the anode of the mixer is connected to the start (or inside) of the primary winding, then the grid of the i.f. amplifier valve should connect to the finish (or outside) of the secondary winding. Alternatively, if the anode connects to the finish of the primary winding, the grid should connect to the start of the secondary winding. This method of connection enables inductive and stray capacitive couplings between the windings to be mutually aiding, and assists in obtaining a good overall response from the transformer. The same point applies to the second i.f. transformer, and the end of its secondary winding which connects to the detector diode should be similarly "opposite" to the end of the primary winding which connects to the anode.

To obtain a good i.f. response it is also desirable to keep stray capacitances between the anode and grid (or detector diode) terminals of the i.f. transformer as low as possible. The corresponding tags are usually spaced as far apart as possible on the transformer base and the external connecting wires to these tags should also be kept well spaced.

In Fig. 5 the lower end of the secondary winding of the first i.f. transformer couples direct to chassis. In a standard receiver, this connection would be to a source of voltage which offers *automatic gain control*, and we shall show the circuit alterations required when we come to that subject.

As a final point, the screen grid of the i.f. amplifier valve in Fig. 5 is supplied by way of its own feed resistor and bypass capacitor. A common approach, particularly in domestic a.m. receivers using the ECH81 triode heptode, is to use a single resistor for the screen grids of both the i.f. amplifier and the mixer, these being bypassed to chassis by a single capacitor. This arrangement, which saves two components, is illustrated in Fig. 6.

NEXT MONTH

In next month's issue we shall conclude on the i.f. amplifier and then carry on to the detector stage. ✪

MICROELECTRONICS

Congress Theatre, Eastbourne, 3-5 June 1969

A conference on microelectronics will be held at the Congress Theatre, Eastbourne, during the period 3 to 5 June 1969.

Further details will be announced during October 1968.

In your workshop

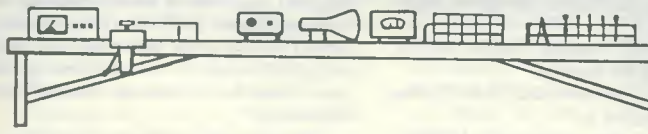

Many snags in television receivers are 'straight out of the textbook'—provided we can recognise them as such! This month Dick encounters his most baffling mystery yet, and has to fall back on the experience and advice of the Serviceman to uncover the simple explanation behind the Riddle of the Glowing Valve

"This," beamed Dick, "is going to be luxury!"
Smithy turned round from his bench.

"Luxury?"

"Yes," repeated Dick happily, "luxury indeed."

He waved a careless arm at the rather venerable 17in. television receiver he had brought over from the "For Repair" rack.

"It's a real pleasure just to contemplate that set," he said exultantly. "To start off with, its 405-line only, which means that I haven't got to mess around with 406-625 line switching circuits. Also, it's got a 90 degree tube, which means that there's stacks of room to play around with inside the cabinet. And, finally, all the resistors and capacitors are connected to neat little tagstrips, so that I can sort out exactly where they connect without any complications whatsoever."

Smithy concentrated his gaze on Dick's receiver.

"I remember that model very well," he remarked musingly. "It was one of the last TV receivers to be produced in this country with conventional wiring, before the manufacturers changed over to printed circuits. It's a bit ancient now, I suppose, but it should still be worth fixing if it hasn't got too many faults in it."

The Serviceman heaved a nostalgic sigh.

"I must confess," he continued, "that I occasionally miss servicing those old sets with conventional wiring. I know that printed circuits aren't all that difficult but, even so, it was pleasant to work on a nice sturdy chassis which had all the connections and components on one side."

Dick looked at the Workshop clock.

"There's an hour and a half to go before packing-up," he announced. "That time will go very agreeably if I spend it with this TV. According to the label tied to it, sound is O.K. but there's no picture. It looks like a pretty straightforward snag."

"Don't be in so much of a rush to count your chickens," chuckled Smithy. "Some of the simplest snags of all can still offer baffling symptoms!"

No Video Response

As Smithy turned back to his own work, Dick applied his full attention to the TV receiver. Setting it in a convenient position on his bench he plugged in an aerial lead, connected the set to the mains, swung the turret tuner to a local channel and switched on. After a short wait sound became audible from the speaker whilst, a little later, a 10,125c/s whistle from the line output transformer inside the cabinet announced the

imminent appearance of e.h.t. voltage. However, there was no picture. Instead, a blank raster of good brilliance became visible on the screen. To avoid distraction due to the sound programme, Dick turned down the volume control. He next experimented with the other controls, but to no avail. All that appeared was the blank raster when the brightness control was at its maximum setting, as it had been when Dick had first switched on.

"Smithy," called out Dick cheerfully, "I said it would be an easy one! The e.h.t. is O.K. and the brightness control seems to work all right, so there don't appear to be any faults in the tube itself. Also, the line and vertical timebases are both scanning the tube. What I've got here is just a simple loss of video somewhere along the line!"

But Smithy had now become immersed in the chassis on his own bench, and he merely gave a perfunctory grunt at Dick's news.

In excellent spirits, Dick returned to his receiver and moved it round so that its back was towards him. He switched off, unplugged the aerial and mains connectors so that he could remove the back, and then unscrewed the bolts which secured this in position. That task accomplished, he refitted the mains connector, switched on again and gazed benignly into the dark interior of the cabinet. The gloom was gradually relieved by a dozen or so cheerful red glows from inside the envelopes of the valves as first their heaters, and then their cathodes, came to full operating temperature. Maintaining his benevolent appraisal of the valves spaced around the ample chassis, Dick plugged in the aerial lead.

The glow from one of the valves increased in brightness.

Dick frowned a little uncertainly, then pulled the aerial lead out of the receiver socket.

The red glow from the valve dimmed, reaching its previous level after a period of several seconds.

Unbelievably, Dick re-inserted the aerial plug whereupon the valve obligingly increased the brilliance of its glow. Dick removed the aerial plug and the glow slowly dimmed once more.

Scratching his head, Dick directed his attention to the other valves in the receiver. These maintained their continual steady glow regardless of whether the aerial was plugged in or not. Dick came back to the rogue valve and examined its behaviour closely.

There was no mistaking the effect. When the aerial was plugged in, the glow from inside its glass envelope increased in intensity. When the aerial was removed, the glow returned to its former level.

"This," muttered Dick, "just cannot be true."

Decisively, he reached round, switched

off the receiver and, using a rag from the bench to handle it, pulled the valve of variable intensity out of its socket. It was a PCF80. Dick examined it critically. It looked the same as any other PCF80.

Wearing what was, by now, a decidedly worried expression, Dick walked over to the spares cupboard and carefully selected a new PCF80. Returning, he plugged it into the receiver chassis and switched the set on again. After a short while the new valve warmed up and emitted a red glow just like its predecessor. With a faltering hand, Dick plugged in the aerial yet again.

The glow from the new PCF80 increased in brilliance.

"Oh no," moaned Dick. "Not this one, too."

But it was that one, too; and when a shattered Dick finally nerved himself to remove the aerial lead from the receiver socket, the glow from this new PCF80 also diminished slowly, in just the same manner as had occurred with the original one.

Logical Deduction

"Smithy," yelled out Dick, "for the love of Pete come on over here and save me from an incipient nervous breakdown! Either the strain of life in the Workshop has caused me to go completely doolally or I've stumbled on something new which has never before been encountered in electronics!"

Startled at the tone of urgency in his assistant's voice, Smithy quickly put down his soldering iron and hurried over to Dick's side.

"I thought," he grumbled irritably, "you said that the fault in this set was going to be an easy one."

"It still could be," retorted Dick, "if I had a couple of telepathic mediums to help me sort it out instead of an ordinary

testmeter. This flaming receiver is haunted, mate!"

"Nonsense," snorted Smithy. "Tell me what it does."

"So far as I can make out," said Dick unhappily, "the heater current in one of the valves goes up whenever I plug an aerial in! And the heater current goes back to its previous level after I've taken the aerial out again! This happens with both the original valve and with a new one."

Smithy's eyebrows rose.

"You'd better show me."

"Just look at that PCF80 over there," said Dick, pointing with a trembling finger at the glowing valve in the receiver which had caused him so much mental anguish. "Does it seem like an ordinary valve to you?"

"It appears," replied Smithy mildly, "to be perfectly normal."

"I'm now," pronounced Dick, "going to plug the aerial in."

He refitted the aerial and, dutifully, the valve radiated its increased glow.

"Now, that's interesting," stated Smithy. "Pull the aerial out again."

Dick did so and, once again, the glow from the valve diminished.

"Yes," repeated Smithy, thoughtfully, "there's something here which is quite intriguing. What's called for now is a spot of logical deduction. To start off with, am I correct in assuming the pretty obvious fact that this set is tuned in to a live channel?"

"Oh, definitely," replied Dick. "I've got it switched to our local BBC-1 signal. As you know, that really belts in on our aerial."

"Fair enough," said Smithy. "We can, therefore, establish one fact. Which is that the visible glow from that valve increases whenever a good strong signal is applied to the set."

"And that brings us," returned Dick, "to our first impossibility! The valve heaters in this receiver are all in series so it would be impossible for the heater current in just one to go up."

"An increase in heater current in one valve only," said Smithy contemplatively, "is just about feasible, I would guess, if the heater were at the chassis end of the chain. But I doubt very much whether such a thing is, in fact, taking place here at all."

"Then," returned Dick triumphantly, "what we have both seen is just not happening!"

"Of course it's happening," replied Smithy irately. "As a matter of fact I'm already prepared to make a fairly inspired guess as to what's causing the increased glow, but I won't say anything until I've got a few more facts to work on. All I'll state for the moment is that there must be an obvious fault in your reasoning."

"How come?"

"You say that what's occurring here is impossible," pronounced Smithy. "But it obviously isn't impossible because we've both observed it. Now, the only reason you think it's impossible is because you've inserted an incorrect assumption between what you've seen and your interpretation of what you've seen."

"Blimey," said Dick. "This is getting a bit too deep for me."

"Don't let it worry you," replied Smithy cheerfully. "What you can do now is to get the works of that set out, whilst I take a swift shufti at its service sheet."

Smithy walked towards the cupboard where the service manuals were kept whilst Dick busied himself with removing the television chassis from its cabinet. As Dick withdrew the chassis, a satisfied chuckle from the Serviceman reached his ears.

"What's so funny?"

"Nothing really," replied Smithy soothingly. "It's only now I've seen the circuit for this TV, that my inspired guess looks like becoming a one hundred per cent certainty."

"I hope it is," growled Dick ungraciously. "So far as I'm concerned, this set has got a jinx on it, and that's all there is to it."

"Well, don't get all aeriated about it," retorted Smithy. "You'll soon be fully in the picture yourself. For the time being, however, just connect that chassis to the mains, switch it on, then have a look at this circuit."

Obediently, Dick connected up the chassis and switched it on. He then transferred his attention to the service manual.

"Now," said Smithy, stabbing his finger at the circuit in the manual, "the PCF80 which is acting so strangely is this one here and, in passing, I'll just draw your attention to the fact that its

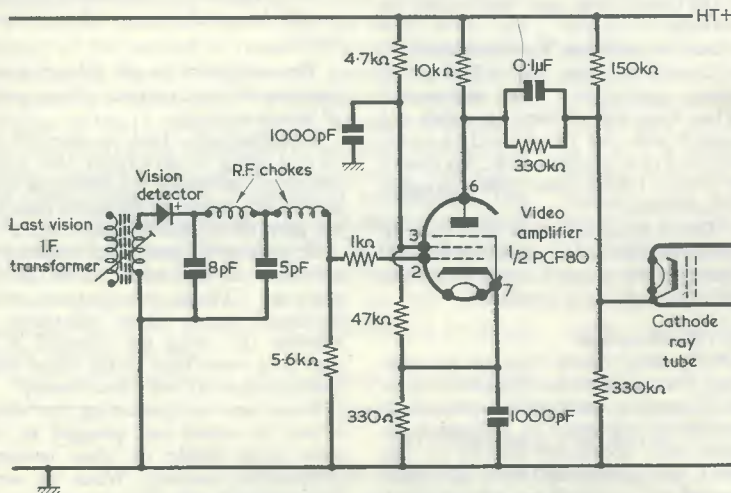

Fig. 1. In Dick's receiver the pentode section of a PCF80 functioned as video amplifier in the basic circuit shown here, which gives all relevant resistor values

heater is nowhere near the chassis end of the chain. Now, let's look at its two sections. The triode section of the PCF80 is the line oscillator in this set, but I don't think it's contributing to the trouble. The pentode section, on the other hand, is the video amplifier and I'm pretty certain that we'll find the cause of the mystery here."

Dick gazed blankly at the circuit of the video amplifier stage incorporating the PCF80 pentode. (Fig. 1).

"Well," he remarked dubiously, "I suppose we *could* say that the triode section is O.K., because we can hear the line output transformer whistling and because we're getting e.h.t. And I suppose we *could* also say that the pentode section is the one that's on the blink, because we haven't got any video going to the tube. But what these points have to do with the heater glowing brighter when the aerial is plugged in just passes my comprehension!"

"You're still," Smithy reproved him, "working from incorrect premises."

"The only premises I know about," snarled Dick indignantly, "are *licensed* premises!"

"Perhaps so," growled Smithy. "And I would remind you that licenced premises have optics and so have you, and I wish you'd start using *yours* a bit more! If you cast your eyes over this circuit you'll see that the vision detector following the last vision i.f. transformer is connected so that it passes positive-going video to the control grid of the PCF80 pentode. This is 405 lines and, as the modulation is positive, the grid goes more positive as the transmitted scene goes brighter. The amplified video at the anode of the PCF80 pentode goes negative with increased picture brightness, and this signal is passed to the cathode of the tube. Which is all very simple and straightforward. So far as components are concerned, the anode load of the pentode is a 10kΩ resistor, whilst the screen-grid connects into a fixed potentiometer given by a 4.7kΩ resistor, a 47kΩ resistor and a 330Ω resistor in series. The cathode also connects into this potentiometer, at the junction of the 47kΩ and the 330Ω resistors. All right so far?"

"Up to now," commented Dick, frowning thoughtfully, "I can't see anything which seems at all unusual."

"Right," said Smithy briskly. "Then we'll get down to a bit of practical trouble-shooting. Get your testmeter out and check the voltages with respect to chassis on that 10kΩ anode load resistor."

Dick pulled the meter towards him, selected a suitable voltage range, and clipped its negative lead to the chassis of the receiver. He picked up the positive prod and examined the chassis. After a moment, he applied the prod to a tag near the valveholder of the PCF80.

"Here we are," he called out. "I'm now checking the h.t. positive end of

that 10kΩ resistor. And the meter's reading almost exactly 200 volts."

"Try the other end."

"Half a mo! Right, I'm now checking the anode end of the 10kΩ resistor. Why—blow me—it's giving the same voltage!"

"There can't," pronounced Smithy, a satisfied gleam appearing in his eye, "be much current flowing through that resistor, then. Try the pentode anode voltage at the valveholder tag itself. It's pin 6 by the way."

Dick applied his test prod to the valveholder tag.

"Still," he remarked, "200 volts."

Smithy looked slightly surprised.

"Does the solder joint at that tag," he asked a little anxiously, "look O.K. For instance, it's not a cold joint or anything like that, is it?"

"Definitely not," replied Dick with conviction. "It's a perfectly good joint. Besides, I'm getting that 200 volts from the metal of the tag *after* the solder joint."

"All right, then," said Smithy, his voice carrying a tone of mild vexation. "It looks as though the actual fault itself is going to be one of these annoying minor ones. Keep an eye on that anode voltage whilst I waggle the valve in its holder."

Smithy leaned forward and rocked the valve.

"No change here," announced Dick.

Clicking his tongue in annoyance, Smithy rocked the valve more vigorously in its valveholder.

"That's done something!" called out Dick. "The meter needle dropped for a moment when you did that."

"Thank goodness," said Smithy. "I was beginning to think that my little pet theory wasn't working out correctly after all. I'll plug the aerial in next, because this will show what's happening more dramatically."

Smithy connected the aerial lead to the chassis and returned to his manipulation of the valve. Suddenly, the blank raster presented by the tube changed to a heavily over-contrasted picture. This flickered a little until Smithy found the exact position of the valve in its valveholder which was needed to

maintain it, and then the picture remained steady.

FAULTY VALVEHOLDER

With a gesture of triumph, Smithy released the valve, whereupon the blank raster returned. He switched off the receiver and turned a gratified eye upon his assistant.

"There you are," he pronounced, "a faulty valveholder. The contact which connects to the anode pin must have broken."

"Don't tell me," remarked Dick unbelievably, "that *that* was what was wrong."

"I'm afraid so," Smithy consoled him.

"Irritating, isn't it?"

"And that faulty valveholder," continued Dick incredulously, "was causing the varying heater current as well?"

"Not exactly," replied Smithy airily. "In actual fact the heater current wasn't varying at all."

"Then what on earth," asked Dick in despair, "was causing the glow from the valve to go up when I plugged the aerial in?"

"The screen-grid."

"The *what*?"

"The screen-grid," repeated Smithy. "Not only was the heater, together with the cathode, providing a visible glow, but so also, with the aerial plugged in, was the screen-grid. I must admit that it would be quite easy to mistakenly assume that the extra glow was coming from the heater because, apart from a few small holes in the side, the anode of a PCF80 pentode completely encircles the other pentode electrodes. Also, the gettering at the top of the valve envelope prevents you looking down directly into the electrode structure. (Fig. 2). So, the only impression you would get is of a general glow from inside the works of the valve. When the red-hot screen-grid added to that glow, therefore, it was reasonable for you to assume that the heater current had gone up. However," concluded Smithy severely, "since it later became obvious that the heater current couldn't possibly go up, you should have started thinking of something else instead."

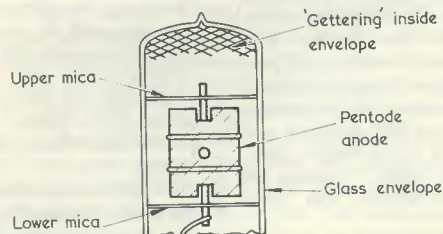

Fig. 2. Side view of the upper section of a typical PCF80, showing the shape of the pentode anode. The triode section is behind the pentode in this view

"I'm beginning to see what you were talking about earlier," replied the discomfited Dick, "when you said I was working from a false assumption. But, even so, why should the screen-grid glow red?"

"There is one main reason for that," explained Smithy. "You see, if the h.t. supply to a pentode anode is broken, as had occurred in this instance, all the dissipation inside the valve is taken up by the screen-grid. That is to say, all the electrons from the cathode which previously passed through the screen-grid to the anode now end up at the screen-grid itself. The screen-grid is then called upon to dissipate considerably more heat than it would normally have to handle, and it is quite a common occurrence for the screen-grid wires of a pentode to become really bright and red-hot when a break in the anode circuit causes screen-grid dissipation to become excessively high. Modern pentodes are tough, and their screen-grids can stand up to this maltreatment for quite a while before they finally fail completely. The maltreatment doesn't do them any good, of course, and when you've replaced the valveholder in this set you'd be well advised to ditch the two PCF80's that have been in it as well, then fit a brand new one. The life of those two PCF80's will have very probably been shortened by the bashing their screen-grids have taken."

Smithy paused for a moment.

"We turn next," he went on, "to the business of the glow increasing when you plugged the aerial in. Now, with no signal applied to the receiver, there is no output from the vision detector, and the grid of the PCF80 pentode video amplifier is at chassis potential. At the same time its cathode has a positive bias because it connects into the potentiometer given by the 4.7kΩ resistor, the 47kΩ resistor and the 330Ω resistor in series. The valve therefore has a reasonable bias and the screen-grid dissipation resulting from the open anode circuit might not cause it to glow or might be just enough to cause it to glow relatively dimly. When you plugged the aerial in, though, a dirty great positive-going signal was at once passed from the vision detector to the control grid of the valve. This considerably increased the electron flow from the cathode, with a consequent large increase in screen-grid dissipation. As a result the screen-grid got good and hot and gave off a really bright glow. And that," Smithy ended, "explains the mysterious effect which you were watching."

PENTODE ANODE CIRCUITS

"Stap me," said Dick inelegantly. "This red-hot screen-grid business is something I've never even heard of before."

192

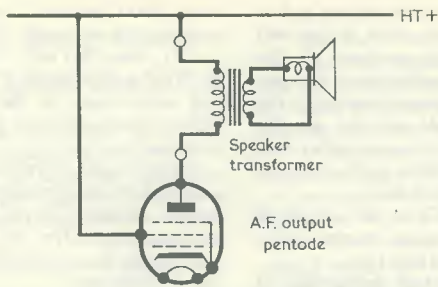

Fig. 3. It is common practice to connect an a.f. output pentode into a circuit of the type given here. In some instances, a smoothing resistor may be inserted in the h.t. positive line between the points at which the anode and screen grid circuits connect

"As a matter of fact," replied Smithy, "it's quite an oldie. You bump into it now and again in pentode a.f. output stages where the screen-grid connects direct to the h.t. positive line. (Fig. 3). In this case there is no limiting resistance in the screen-grid circuit at all, with the result that, should the speaker transformer primary go open-circuit, the screen-grid is liable to start glowing away like a miniature lighthouse. In this respect, incidentally, you have to be particularly careful when servicing valve receivers which have the speaker transformer mounted on the speaker frame, with two flying leads from the chassis going to the speaker transformer primary. It's quite easy for one or both of these leads to become disconnected, whereupon you're liable to be lumbered with one defunct output valve as a consequence. If you have to disconnect the leads to the speaker transformer primary when you're removing the chassis from the box, always make certain that they're re-connected before switching on again."

"What about pentodes used as r.f. amplifiers and things like that?" asked Dick. "I'm certain that I've used these in the past with their anodes disconnected from h.t. positive, and I'm quite sure that their screen-grids never went red-hot."

"They wouldn't," said Smithy, "although their screen-grid dissipation would still have gone up, nevertheless. However, the normal dropping resistor in series with the screen-grid of an r.f. pentode prevents the flow of too much current. The a.f. output pentode represents the worst case, because the screen-grid connects direct to the h.t. positive line without any series resistance at all."

"There's series resistance in the video amplifier circuit that PCF80 pentode was connected in," Dick pointed out. "There's a 4.7kΩ resistor between the screen-grid and h.t. positive."

"True enough," agreed Smithy. "And whilst that 4.7kΩ resistor will limit the dissipation actually suffered by the screen-grid it obviously isn't large

enough in value to prevent it from cooking up to a bright red. Let's try a few simple calculations. Rough check, maximum screen-grid dissipation in the PCF80 pentode will occur when the screen-grid is at half the h.t. potential, which means a screen-grid current flow of something like 20mA at 100 volts. That little lot comes out as 2 watts, which is quite a bit when one considers that the maximum permissible dissipation for a PCF80 pentode screen-grid under normal working conditions is only about 500 to 750 milliwatts. As it happens, although the PCF80 pentode isn't exactly what one would call a "power valve," it was used as video output valve in quite a lot of receivers around the time the set on your bench was made. Later receivers tend to have more powerful video output valves which can stand up to higher dissipations than the PCF80 pentode. I doubt if you'd get anything like as bright a screen-grid glow from these if their anode circuit was opened and if there was a resistor of 4.7kΩ in series with the h.t. feed to the screen-grid."

"I certainly," complained Dick, "seem to have my share of bad luck. Not only do I get a really weird set of fault symptoms, but I also happen to pick the set in which those symptoms are most likely to happen."

"Not to worry," chuckled Smithy. "It's all part of experience. As soon as I saw the service manual circuit diagram and realised that the PCF80 pentode was the video amplifier I was pretty certain about what was going on, and that the anode circuit of that pentode had gone open. I didn't expect that we'd have to work all the way back towards a faulty valveholder pin to find where the break was, though."

"Which is another rather unusual fault," commented Dick. "Incidentally, why are you so certain about the valveholder? Couldn't it be a dirty valve pin?"

Smithy threw his hands up to the ceiling in despair.

"My life, oh my life," he moaned. "You told me before I started working

on the set that you'd already tried two valves in that valveholder."

"Why, so I did," returned Dick brightly. "Oh well, I'll get stuck into fitting a new valveholder now. That, at least, is something I *can* do without making any errors or mistakes."

NEW VALVEHOLDER

And indeed, when Dick had completed the replacement of the valveholder the new component was secured firmly in

place, with every soldered connection immaculately and properly made.

Dick fitted the final new PCF80, checked the chassis, then returned it to its cabinet. A careful test showed that the receiver was now working perfectly, and that there was no trace whatsoever of any disturbing variance in the glow from its valves.

Whereupon yet another meritorious repair can be chalked up to the credit of the Workshop. After such a successful

outcome to this particular adventure it would be fitting to turn to a more inspired pen to provide the final conclusion for our story. A latter-day Blake might well, for instance, have written the following lines:

*Pentode, pentode, shining bright,
Glowing forth with eldritch light,
What immortal hand or eye,
Dare break thy anode circuitry?*

But only, we must hasten to add, after having suffered an excess of dissipation.



WORKSHOP TAPE RECORDING

by N. KING

A tape recorder in the shack is a very useful item of equipment. At the workbench, voltage and current readings, at various points in the circuit under construction, can be recorded on tape instead of using the more conventional notebook. The average workbench is apt to be rather small and is moreover, during periods of construction, rather crowded, leaving little room for a notebook, pencil, and necessary elbow room. A tape recorder microphone on the other hand occupies little space and may be suspended in a convenient position above the workbench—the recorder being placed elsewhere. The voltage and current readings may be played back during any convenient time at a later date. Additionally, of course, during the process of constructing a particular unit, notes may be made of the various connections still to be soldered etc. Thus, a continual running record of the constructional process may be put on to tape, this being played back to act as a "memory" when a later building session is commenced. Also, ones own ideas on the circuit and possible future modifications may be recorded.

At the operating bench, the use of a tape recorder when receiving either amateur or broadcast stations is of very great use to the operator. On the amateur bands, any QSO may be "put on ice" for future reference. This is particularly useful when a report is later made out for submission to the station concerned. This releases the operator from the necessity to hurriedly scribble down every scrap of information likely to be included in the report. With the QSO on tape, all those items such as QRM, QSB, QRN, time GMT, frequency and signal strength, etc., may be recorded during or after the QSO. The report can then be compiled at a more convenient time. Additionally, of course, especially when operating on Top Band, a tape may be sent to the station being recorded; this will almost certainly bring a QSL card back in a very short time—this particularly applying to a new licence holder.

On the Broadcast bands, the use of a tape recorder makes the task of the operator very much simpler. When receiving those elusive rare S. American Dx stations, its use greatly assists in the identification of the station concerned. Whereas, previous to the use of a recorder, station announcements had to be resolved during the brief period of time the identification signal, etc. is radiated, this may now be taped, the frequency, time, and other details recorded, and identification made at any convenient later date. Where identification was formerly difficult, or even *almost* impossible, owing to the language difficulty and mis-hearing of name places during the fleeting moments in which these announcements are made, these may now be resolved by playing them back, again and again, until positive identification is made. This means that many Dx listings that were once missed are now capable of being entered in the log.

Many broadcast stations are pleased to accept a 2in spool of tape recording their broadcast and this is, in most cases, returned with the QSL card and a letter of appreciation. Many top line broadcast band operators use this method of reporting to a station from which they are particularly interested in obtaining a card. The submission of a tape does not, of course, guarantee a QSL card—but it will prove to be almost 90% of the battle in obtaining the coveted card from a Dx station.

A tape recorder in the shack will not only prove to be useful as an operating aid, both on the operating and workbench but will also serve as a "memory" and information store that can be tapped at any time. Lastly, for those who wish to learn the morse code, it can obviously serve a useful purpose by playing back recorded morse, which has been taped at various speeds from differing stations, at any time and for any period selected by the user. Once equipped with a tape recorder, the enthusiast will soon find it an invaluable piece of equipment and one of the most important units in the shack.



COMPUTERS IN SCIENCE AND RESEARCH

THERE IS HARDLY ANY FIELD OF ENDEAVOUR where measurements and computations are so much needed as in science and research. It was therefore only natural that years ago efforts should have been concentrated on finding an expedient with which to do routine computational work much quicker, more exact and with a smaller range of error than the human mind was ever able to achieve.

Since the introduction of efficient and safely operating computers, scientific tasks have already been assigned to this equipment, and it was very soon found that the computer handles routine work out of all proportions to man's capability. The first thing that strikes one is the enormous arithmetic speed which is higher than that of the human mind by millions or even billions. This is due to the fact that the individual states of circuitry can be changed within some micro- or nanoseconds. Even beyond the arithmetic operations the computer is able to select data under certain aspects, make a logical decision and store important figures or intermediate results for later use. Long vistas of hitherto undreamt-of opportunities opened up and some rushed to the conclusion that in this way all problems might shortly be solved with the aid of computers. It soon turned out, however, that the computer cannot be any wiser than the programme fed into it.

If larger arithmetic operations turn up, the crucial question is that of storage location, where intermediate results are stored until they are needed again for further computations. When setting up a programme, attention must therefore be paid to a highly efficient use of the storage location. All data no longer required should be erased instantaneously, and the programme should be written out so that intermediate results need be retained in the memory for a minimum time.

The computer is an ideal tool for scientific investigations and for all research work. But as with every tool or instrument, success is not achieved unless it is handled and used properly—

the road to solving problems by the computer can be known only by man himself.

The scientist is now in a position to assign tiring, and often time-consuming work, via programme to the computer, so that he has more time available for using his creative imagination. It is not only in computation, but also in the more accurate recording and control of experiments that the computer can do valuable work.

Today, experiments are observed by means of a control system through an arrangement of transfer elements which change the measured variable into a certain figure at the indicator or into a graph appearing on the pictorial screen. This is the only way to measure important physical and chemical variables during experiments.

There appears to be another field of employment in the offing. The computer not being limited to an evaluation of certain data if it is placed direct in the measuring system, and the individual variables, such as pressure, temperature, rate of flow, are no longer observed, but instead a pilot variable is pursued through the computer, such a pilot variable being interrelated with all other variables. This scheme offers the opportunity of following up a compound variable during the entire experiment, which calls for special attention throughout the process, and thus to get a better grip on the process itself and to analyse it more efficiently through time.

Previously an experiment had to be run first in order to be evaluated later. It was thus not before completion of the experiment that its results were available for evaluation. Today the computer furnishes intermediate results throughout the process, which contain more accurate information about, and permit closer judgment of, the details of the process.

In future, small-scale computers will probably be used to change process variables into digital information, bring it in suitable form, and transmit it to a central computer installation.

Radio

Topics

By Recorder

ONE OF THE ELECTRICAL DEVICES which should, in theory, have started to die as soon as the more sophisticated types of semiconductor component appeared on the scene is our old friend, the relay. But the relay doesn't show any signs of dying at all or, even, of fading away. Instead, it continues to flourish and to maintain its popularity.

When compared with a semiconductor switching device the relay is, really, quite a cumbersome component. It is bulky and weighty, it requires a relatively large amount of power for energising, and it relies for its operation on a mechanical action which can easily become erratic due to wear, maladjustment or the ingress of dirt. Again, most standard relays suffer from quite severe "backlash" insofar that the coil voltage required for energising is considerably higher than the voltage at which the relay releases. And, finally, the relay takes an appreciable length of time to energise and to release.

RELAY ADVANTAGES

Despite all these shortcomings, relays still continue to be incorporated in both amateur and professional designs. I would suggest that there are two main reasons for its popularity here. One of these is the purely technical advantage that any circuit switched by the contacts of a relay is completely isolated from the circuit which actuates it. The other is that the functioning of a relay can be very readily seen and understood.

I have a great affection for the relay myself since I have, in the fairly distant

(and pre-semiconductor) past, worked with equipment in which relay circuits carried out quite complex "thinking" operations. We didn't talk in those days of AND gates or OR gates, but our relay circuits carried out exactly the same functions as do such gates. It is, of course, a piece of cake to wire up two relays to form an AND gate. If a pair of make contacts (i.e. contacts which close when the relay energises) on each relay are wired in series and applied to an external circuit, that circuit will only be completed when both relays energise; thus giving us the AND function. If, on the other hand, the make contacts are wired in parallel, the external circuit will be completed when either one or both of the relays is energised, whereupon we have an OR gate.

Transfer the external circuit connections I've just mentioned to a pair of break contacts (contacts which open when the relay energises) on each relay, and you have a NAND gate and a NOR gate respectively. Blimey, we were doing this sort of thing *ages* before the Boolean Algebra boys moved in!

The relay gates I've just described are obviously more unwieldy and slower in operation than the corresponding semiconductor gates, but they are still of much interest to the experimenter. And, because of the complete isolation between energising and switching circuits that they provide, they are of considerable use for professional applications as well.

Another useful attribute of the relay is its ability to "hold on". If a make

Your Local Supplier

LONDON

Established 1910

**H. L. SMITH
& CO. LTD.**

Comprehensive stocks of components
by all leading makers.

287-9 EDGWARE ROAD
LONDON W.2
Tel: 01-723 5891

**TELERADIO
ELECTRONICS**

For Radio Control Devices, Miniature
components, Special Transistors,
Circuits and data on boat and
aircraft control.

QUOTATIONS GLADLY FOR PARTS USED IN
MAGAZINE ARTICLES

(S.A.E. Enquiries REF. D/P)

325/7 FORE STREET,
EDMONTON (3719)
LONDON, N.9.

**THE
MODERN BOOK CO.**

Largest selection of English and
American radio and technical books
in the country.

19-21 PRAED STREET,
LONDON, W.2
Tel: PADdington 4185/2926

**ELECTRONICS
GALORE!**
in the NEW
dca CATALOGUE
Send 1/6 now for your copy
to: DEPT. R/C
**dca ELECTRONICS
LIMITED**
28 UXBRIDGE ROAD,
EALING, W.5

OCTOBER 1968

THE RADIO CONSTRUCTOR

Your Local Supplier

LONDON

ST. HELEN'S RADIO

Hi-Fi Equipment
Tape Recorders
Radio Receivers
Television

SPECIALISTS IN RADIO
& ELECTRONIC TEXTBOOKS

ST. HELEN'S GARDENS
LONDON W.10
Tel: 01-969 3657

ESSEX

ELECTRONIC COMPONENTS

Valves, transistors, capacitors,
transformers, amplifiers,
tuners, etc., etc.

335 GREEN LANE,
SEVEN KINGS,
ILFORD, ESSEX.

Telephone: 599-1826

MARKET CENTRE For Semiconductors

Prompt, efficient mail order service for Mullard, Newmarket, Texas, Sinclair, S.T.C., Fairchild Semiconductors. We also offer a comprehensive selection of miniature components for transistor circuitry. Catalogue 1s.

L.S.T COMPONENTS
23 New Rd., Brentwood, Essex

BOURNEMOUTH

LARGEST HI-FI AND
RADIO COMPONENT
STORE IN THE SOUTH

FORRESTERS NATIONAL
RADIO SUPPLIES LTD.
70-72 Holdenhurst Road
Bournemouth
Telephone 25232

contact set on-a relay is wired so that, when the relay operates, it couples an energising supply to its coil, the relay stays operated until that energising supply circuit is broken. G. A. French took advantage of this factor a long time ago in one of his earlier "Suggested Circuits". The application was for the remote control of mains operated valve equipment and the circuit operated in the following manner. A pair of make contacts on a relay sited at the equipment to be switched were in series with its mains supply, whilst the relay coil coupled to the remote control point via a pair of lines. One side of the relay coil was connected, also, to the equipment chassis. When, at the remote point, a battery was connected to the lines (with negative to the line connecting to the equipment chassis), the relay energised and switched on the equipment. A second pair of make contacts on the relay then connected the non-earthly side of the relay coil to the equipment h.t. positive rail via a suitable dropping resistor. The result was that, as soon as h.t. appeared, the relay "held on" via its own contact and the battery at the remote point could be disconnected. To switch off the mains equipment, the lines at the remote point were short-circuited. This caused the relay to de-energise and the mains equipment to switch off again. The relay chosen required an energising current of about 10mA or so, this being the extra current drawn from the equipment h.t. supply via the dropping resistor. The current drawn would increase slightly when the relay coil was short-circuited from the remote point for switching off. The remote control circuit was intended for equipment having an isolating mains transformer, with the result that the lines to the remote point became completely isolated from the mains despite the fact that they switched on and off an item of equipment running direct from the mains. And, finally, the battery at the remote point had a long life because it was only required to energise the relay for the short period between switching on the mains and the appearance of an h.t. supply.

Neat, isn't it? Just one relay, and a circuit application that is both simple to understand and reliable in operation. There are quite a few other tricks of the same type which can be carried out with relays, as a perusal of back issues of *The Radio Constructor* will soon demonstrate. Periodically, we publish constructional designs in which a relay carried out at least one important function.

The fact that relays still flourish is amply borne out by the fact that they appear in the catalogues of all the mail-order general component supply houses. Provided it is used intelligently, the relay has a continuing rôle to perform, and I have little doubt that it will be many years before it finally gives

precedence completely to its semiconductor successors.

SEEING IN THE DARK

Just announced by Mullard Limited are details of an equipment capable of "seeing" in the night under starlight conditions. This takes advantage of a special Mullard image intensifier tube and it works entirely with light reflected from the object or scene being observed. It does not rely on infra-red illumination.

The image intensifier tube has a wide diameter objective lens to collect as much as possible of the light reflected from the object or scene, this being focused on to a photoemissive surface (the photocathode) which emits electrons according to the intensity of the light falling on it. These electrons are then directed and greatly accelerated by means of internal anodes to a phosphor screen at the other end of the tube. The image on the photocathode is reproduced on the phosphor screen with, because of the high velocity acquired by the electrons, greater intensity.

This represents the first stage of image intensification in the overall equipment. The visual (not electrical) output of the tube is guided by means of transparent fibres (fibre optics) to the photocathode of a second image intensifier tube. A second stage of image intensification takes place and the visual output is then coupled, again by fibre optics, to an "output" image intensifier tube, whose phosphor screen may be viewed by the operator.

The number of image intensifier "stages" in this visual amplification chain can be more, or less, than three, but it seems that three offer the best practical results for night viewing. Each tube requires an e.h.t. of 15kV and the final image is 25mm in diameter.

The sensitivity of the overall system makes it possible to see and clearly recognise individuals and objects under starlight conditions.

The equipment, originally produced in close collaboration with government research establishments for military purposes, has now been de-classified and made available for civil use. There are, of course, many applications for the image intensifier tube, either on its own or "stacked" in cascade, in such things as nature studies of nocturnal animals, security surveillance, astronomy, and closed circuit television in conditions of very low ambient lighting.

Mullard will not be manufacturing complete night viewing equipment. However, a system has been built by scientists at the Mullard Research Laboratories, Redhill, to demonstrate to potential users the performance of the image intensifier tube.

TRAFFIC NOISE

The subjective effect of traffic noise is rather analogous to that of hitting yourself on the head with a mallet. It is

SURREY

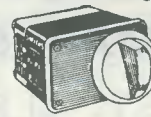

SMITHS PRECISION 6 MINUTE DELAY ACTION SWITCH

Clockwork actuated

10/6 EACH
Post 2/6

(3 or more post free)

Separate switching up to 6 mins. Each action for loading up to 1.5 amps., 250 volts. For photographic timer, sequence switching operations, etc., etc. Brand new units at a fraction of their value. Connection sheet supplied.

Radio Component Specialists

337, WHITEHORSE ROAD,
WEST CROYDON, SURREY
Phone 01-684-1665 FULL LIST 1/-

SUSSEX

E. JEFFRIES

For your new television set,
tape recorder, transistor radio,
and hi-fi equipment.

PHILIPS, ULTRA, INVICTA, DANSETTE,
MASTERADIO, PERDIO, MARCONI,
PHILCO, FIDELITY.

6A Albert Parade,
Victoria Drive,
EASTBOURNE SUSSEX

WORCESTERSHIRE

Dept. C1, 176 HAGLEY ROAD
HALESOWEN
021-550 3210 WORCS.

Hi-Fi Equipment
Transistors and
Radio Components
Public Address Amplifiers

MARLISON
Electronics

EIRE

PEATS for PARTS

ELECTRONIC COMPONENTS
RADIO & TELEVISION

For the convenience of IRISH
enthusiasts we supply:

The Radio Constructor,
Data Books and
Panel-Signs Transfers

Also a postal service

Wm. B. PEAT & Co. Ltd.
28 PARNELL STREET
DUBLIN 1

only when the noise, or the mallet, stops that you realise just how bad it was. If, for instance, you walk along the Marble Arch end of Oxford Street in London on your own any evening you may not fully appreciate the intense racket kicked up by the traffic on this busy thoroughfare; although the noise level is at once brought home to you if you have a companion, because you will find that conversation has often to be carried on at almost shouting level. I choose Oxford Street in the evening as an example because it is an interesting experience to then cross over by one block to the North and walk along the parallel Wigmore Street, with its sparse traffic at that time of day. The difference in noise level between these two streets is almost staggering, and is certainly enough to bring home to you the amount of noise we actually put up with these days.

Because of this excessive traffic noise I, for one, am only too happy to see the new legislation for noise which is now in operation. The maximum noise figure for motor cycles under 50cc is 80dB, for other motor cycles 90dB, for heavy vehicles 92dB, for light goods vehicles 88dB, and for passenger cars 87dB. Many engineers tend to get a little hot under the collar when they first see these dB figures quoted in newspaper and lay magazine articles, because decibels are, of course, nothing other than ratios. However, the dB figures I've just quoted are evaluated against what is known as "A weighting", and are frequently referred to as dBA. Zero dBA is just below the threshold of hearing and 120dBA is just below the threshold of pain.

A company which has been right in the forefront with the measurement of

vehicle noise is Dawe Instruments Limited, of Concord Road, Western Avenue, London, W.3., this company having made the subject a special project in co-operation with the National Physical Laboratory, the Motor Industry Research Association, and police and government departments. The Dawe Type 1409D Vehicle Noise Meter, fully approved by the Ministry of Transport, has been in production for quite some time, and is stated to be the first instrument in the world specifically designed for the purpose. A large number of Type 1409D Meters have already been sold in this country and, when other countries follow our pioneering work in this field, considerable overseas sales are anticipated as well.

Noise measurements are taken with an omnidirectional microphone mounted on a stand at a height of 1.2 metres and a distance of 5 metres from the kerb on an open stretch of road. The Meter itself is positioned some way back from the microphone to minimise reflections from the test station or observers. There must be no buildings or other major obstructions in the vicinity. Battery power, calibration and background noise level are checked at the Meter before commencing readings and immediately after taking any readings on which it is intended to take legal proceedings.

So if, as you drive along the road, you see an innocuous-looking microphone 5 metres in from the road edge and with a lead trailing off to a neat box in the background, don't think that the local tape recording society is getting some background effects for its library. The authorities are checking up on the clatter created by that frightful old banger rattling along just behind you!



CARTOON

H
U
C
K
L
E



"... and I bet the
damn radio is u/s
when I land."



CUTTY.



MARCONI INSTRUMENTS LIMITED

ST. ALBANS & LUTON

**ARE YOU A SKILLED AND EXPERIENCED ELECTRONICS TECHNICIAN?
HAVE YOU BEEN A WIRELESS OR RADAR FITTER IN THE ARMED FORCES?
CAN YOU DO A PROFESSIONAL REPAIR JOB ON A T.V.?**

If you can answer "YES" to at least one of these questions, then we should like to hear from you.

We need test and calibration engineers both at our Government Service Unit at Luton Airport and at our Production Units in St. Albans to work on a wide range of telecommunications measuring instruments, which includes F.M. and A.M. Signal Generators, R.F. Power Meters, Valve Voltmeters, Radar Test Sets, Digital Counters, Deviation Meters, Spectrum Analysers and White Noise Test Sets.

The work requires the understanding of the most modern and varied circuit techniques and embraces all frequencies up to U.H.F.

This is an opportunity to work for an expanding company with a world-wide reputation for technical progress in the design of test equipment. The posts are permanent and pensionable; they offer first-class conditions of service in a key export company of English Electric, including substantial superannuation and life assurance benefits. Financial assistance may be given with re-location expenses.



Write in confidence, stating briefly age, experience, qualifications and present salary, to:—

**The Recruitment Manager, Marconi Instruments Limited,
c/o Directorate of Personnel (RC 2890 H),
English Electric House, Strand, London, W.C.2.**

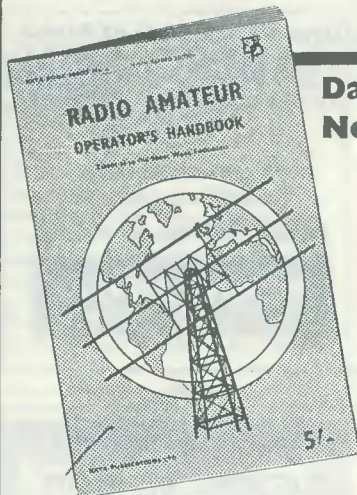

**Data Book
No. 6**

THE RADIO AMATEUR OPERATOR'S HANDBOOK



- ★ AMATEUR PREFIXES
- ★ AMATEUR CODES
- ★ LOCAL TIME CONVERSIONS
- ★ OPERATING TECHNIQUE
- ★ FREQUENCY/WAVELENGTH CONVERSION TABLES
- ★ POST OFFICE REGULATIONS

64 PAGES

Only 5/-

POSTAGE 5d.

Many other essential items

TO DATA PUBLICATIONS LTD 57 Maida Vale London W9

Please supply.....copy(ies) of "Radio Amateur Operator's Handbook", Data Book No. 6.

I enclose cheque/crossed postal order for.....

NAME.....

ADDRESS.....

BLOCK LETTERS PLEASE

AUTUMN SALE ↓

- 4 **FST3/8 STC** Sil. Rectifiers New & Marked 800piv 1½ Amp. Good substitute for BY100 etc. **13/-**
 - 4 **RAS310AF STC** Avalanche Rectifiers New & Marked 1200piv 1½ Amp 5A Surge rated. **20/-**
 - 6 **GJ4M** New & Marked AEI Bermanium Rectifiers 50piv 1 Amp **10/-**
 - 4 **GP297/1** Sub. Miniature power transistors Texas New & Marked. **10/-**
 - 3 **ZF16 STC** New & Marked 16v 300mW Zener Diodes. **10/-**
 - 1 Pair of **AD161/AD162 NPN/PNP** Power Complementary Pair. **15/-**
 - 1 Pair of **AC128/AC176 NPN/PNP** Driver Complementary Pair. **10/-**
 - 1 Set **OC82D + 2 x OC82** Matched Pair New Mullard Marked. **10/-**
 - 4 **BSY95A STC** New & Marked Planar Transistors. **10/-**
 - 4 **BC108** Mullard Latest type Low noise planars New & Marked. **10/-**
 - 6 **NKT276** New & Marked Newmarket Audio General General purpose transistor. **10/-**
 - 36 Square inches of .15" Matrix Veroboard—the most popular pack of all—only from LST. **10/-**
 - 4 **NKT162** New & Marked Newmarket Switching transistor **10/-**
 - 2 **OC19** New & Marked Mullard Power Transistors. **10/-**
 - 5 **BA115** New & Marked Mullard Colour Television Diodes. **10/-**
 - 4 **2G371B** New & Marked Texas Audio Transistors. **10/-**
 - 4 **BYX38/600** Mullard New & Marked Power Studs 600piv 2½ Amp. **16/-**
 - 1 "Designers Guide to British Transistors" New data book with over 1000 types listed—Computer selected substitution chart. Just out from Publishers (Add 2/6d. this item post). **25/-**
- Postage and Packing by First Class Mail now 1/- minimum per order**

TIS43A
Equivalent
2N246 8EN2000
UNIUNCTION 6/9d
including data

2N3819
Texas Field
Effect Transistor
10/-

FAIRCHILD uLogic
uL900 Buffer 1 6 7 12 12+
uL814 Dual Gate 11 9 6 8 4
uL523 JK Flip Flop 14 12 6 11 9
8 Page data, date 2/6d.

TAA263
Linear
Amplifier
IC **19/-**

SCR1 + 2pcIS113
For PE Drill
Controller
(Cddy Issue) **10/- 50t**

BC107/8/9 2/9d

TD716 Tunnel
Diode **12/-**

SILICON RECT'S ★
FULLY TESTED
GUARANTEED

PIV 200mA 750mA 2A 10A	10 6d.	2 1/2	—
100 8d.	1 1/2	2 1/2	4 1/2
200 1 1/2	2 1/2	2 1/2	5 1/2
400 2 1/2	4 1/2	4 1/2	8 1/2
800 3 1/2	6 1/2	6 1/2	11 1/2
1,000 —	8 1/2	11 1/2	—

Post and Packing 9d
Free Export Catalogue

LOOKING FOR QUALITY, VALUE & SERVICE? Write

STOP

2N3707	6 9	AF239	12	OA5	3 8	OC82D	3/-
2N3708	3 9	AF186	12	OA10	4 4	OC83	4/-
2N3709	4 1	AF211	10 8	OA17	1 6	OC84	7/-
2N3710	5 1	AF212	11 9	OA70	1 6	OC123	7/-
2N3711	5 6	ASV27	5 8	OA79	1 6	OC138	8/-
2N3053	5 7	ASV28	4 4	ZC0A70M	4 6	OC205	22/-
2N3055	22/-	ASV26	5 8	OA81	1 6	OC168	6/-
2N3820	25/-	ASV29	4 4	OA85	1 6	OC170	4/-
2G301	4 9	ASV21	11 1	OA80	1 6	OC171	6/-
2G302	3 9	ATJ10	3 0/-	OA91	1 6	OC200	8/-
2G306	9 8	ALV10	39 8	OA95	1 6	OC201	10/-
2G309	10/-	BAV38	3 0	OA202	2 7	OC203	8/-
2G328A	5 7	BC107	4 3	OA210	6 4	OC204	8/-
2G345B	4 7	BC106	4 7	OA211	3 6	OC205	10 6
2G3718	4 7	BC109	4 3	OA2201	3 6	OC206	10 6
2G374B	8 7	BC108	7 7	OA2202	3 6	OC207	7 6
2G382	5 7	BCY31	9 7	OA2205	3 6	ORP12	9 6
2S002	6 7	BCY32	16 7	OA2207	7 7	ORP60	8 7
2S017	8 7	BCY33	4 8	OA2208	3 6	ORP61	8 7
2S018	8 6	BCY34	6 4	OA2243	3 6	ORP63	18 7
2S024	48 7	BCY38	8 7	OA2245	3 6	ORP93	18 7
2S024	28 7	BCY39	27 4	OA2246	3 6	SX658	10 8
2S027	15 7	BCY40	13 4	OA2289	3 6	SX631	7 4
2N705	4 7	AAV11	2 7	BCY54	18 2	SX838	12 7
2N706A	6 8	AAV20	2 7	BCY70	4 4	SZ220	18 7
2N711	7 8	AC107	14 8	BCY71	8 8	OC19	8 7
2N715A	7 8	AC126	6 8	BC211	10 8	CA26	8 3
2N1131	9 8	AC127	6 7	BD121	25 8	CA27	13 7
2N1132	7 8	AC128	4 7	BD123	3 2	CA28	9 3
2N1302	5 7	AC176	7 6	BFX13	4 8	CA29	9 3
2N1303	5 7	AC187	1 2	BFY84	7 8	CA30	14 7
2N1304	5 7	AC188	12 7	BFY90	6 7	CA31	14 7
2N1305	5 7	ACV11	5 6	BFY91	6 7	CA32	14 7
2N1306	5 7	ACV18	3 4	BFY92	6 7	CA33	14 7
2N1307	6 7	ACV19	4 4	BFY93	6 7	CA34	14 7
2N1308	10 8	ACV21	3 8	BFY94	11 7	CA35	14 7
2N1309	10 8	AD129	3 8	BFY95	3 8	CA36	14 7
2N1613	12 7	AD122	2 4	AD123	4 4	CA37	14 7
2N2388	8 6	AD149	11 8	AD149	11 8	CA38	14 7
2N2389	8 6	AD149	11 8	AD149	11 8	CA39	14 7
2N2389A	7 6	AD181	7 6	AD181	7 6	CA40	14 7
2N2648	10 7	AD217	17 7	AD211	21 7	CA41	14 7
2N2147	12 7	AD212	23 4	AD212	23 4	CA42	14 7
2N2148	12 7	AD212	23 4	AD212	23 4	CA43	14 7
2N2160	14 9	AD216	18 7	AD216	18 7	CA44	14 7
2N2923	2 6	AF114	4 8	BY213	7 8	CA45	14 7
2N2926	2 6	AF115	4 8	BY213	7 8	CA46	14 7
2N3262	5 7	AF116	4 8	BY213	7 8	CA47	14 7
2N3203	5 7	AF117	4 8	BY213	7 8	CA48	14 7
2N3704	5 7	AF124	6 7	BY213	7 8	CA49	14 7
2N3705	5 7	AF122	4 7	BY213	7 8	CA50	14 7
2N3706	4 6	AF139	15 7	BY213	7 8	CA51	14 7

LST COMPONENTS
7 COPTFOLD ROAD
BRENTWOOD ESSEX
BRENTWOOD 7904
24 HOUR POSTAL SERVICE

PLEASE SEND 1988 CATALOGUE TO:
(Block Capitals)
I ENCLOSE 1/6 STAMPS
NAME
ADDRESS
(RC4)

NEW FROM TRS

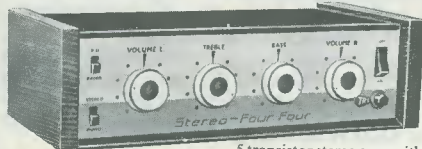

TRS STEREO 4-4

5 transistor stereo amp with pre-amp: Based on newly developed Mullard 4 watt modules with BC.108 pre-amp. Suitable also for speakers from 3 to 15 ohms. Bass and treble cut/boost. Response—60 to 14KHz±3dB. Requires only wiring between controls and modules. Complete with metal chassis and simple teak-ended cabinet for instant assembly. Stereo/Mono and Radio/P.U. switches. Matching Mono/Stereo FM Tuner available shortly.

- GARRARD UNITS AND PLINTHS**
- LM3000 Record Player with 9T.A. Stereo Cartridge. **£10.50**
 - AT.60 Mk. II De-luxe Auto-changer, die-cast turntable. Less cartridge **£13.50**
 - SP.25 De-luxe single record player, die-cast turntable. Less cartridge. **£11.19.6**. Brand new in makers' cartons. Packing and carriage on any one of above 7/6.
- Available to purchasers of above Garrard Units. STEREO Sonotone 9TA/HC Ceramic with diamond, 49/6; Decca/Deram with diamond, 92/6. MONO Acos GP91-1. 21/-; Goldring MX2M. 26/6.

MONEY SAVING LISTS
EIGHT LARGE PRINTED PAGES, PACKED WITH BARGAIN OFFERS, INCLUDING DIFFICULT TO FIND LINES. Send 6d. for LATEST COPY.

WHEN ORDERING
Send cash with order. Post and packing where not stated add 1/- per 4lb; 1 1/2; 11b; 3/6; 2lb; 5/-; 6lb; 6/6; 10lb; 8/-; 14lb; over 14lb, 10/- S.A.E. with inquiries please.

TRS RADIO COMPONENT SPECIALISTS
EST. 1946
70 BRIGSTOCK ROAD, THORNTON HEATH, SURREY
Telephone: 9 a.m.—6 p.m. daily
01-684 2188 1 p.m. Weds. A few doors from Thornton Heath Stn. (S.R. Victoria Section)

FREE TO AMBITIOUS ENGINEERS

—THE LATEST EDITION OF ENGINEERING OPPORTUNITIES

Have you sent for your copy?
ENGINEERING OPPORTUNITIES is a highly informative 132 page guide to the best paid engineering posts. It tells you how you can quickly prepare at home for a recognised engineering qualification and outlines a wonderful range of modern Home Study Courses in all branches of Engineering. This unique book also gives full details of the Practical Radio & Electronic Courses, administered by our Specialist Electronics Training Division — explains the benefits of our Appointments Dept. and shows you how to qualify for five years promotion in one year.

"Satisfaction or refund of fee" terms
Whatever your age or experience you cannot afford to miss reading this famous book. If you are earning less than £30 a week send for your copy of "ENGINEERING OPPORTUNITIES" today — FREE.

Practical Equipment including Tools
The specialist Electronics Division of B.I.E.T. NOW offers you a real laboratory training at home with practical equipment. Basic Practice and Theoretical Courses for beginners in Radio, T.V.; Electronics, etc. Ask for details.

Which is your pet subject
A.M.I.E.R.E. City & Guilds Radio Amateur's Exam. R.T.E.B. Certificate P.M.G. Certificate Practical Radio Radio & Television Servicing Practical Electronics Electronics Engineering Automation
The B.I.E.T. is the leading institute of its kind in the world.

Please send Free Books and Full Information

British Institute of Engineering Technology

NAME
ADDRESS
Subject of Interest Age

ALDERMASTON COURT, Dept. 480D. Aldermaston, Berks.



Happy Families

These are the times when Simon and Ciare know that it has all been worthwhile. But they know too that such moments of happiness are only complete when there is also a feeling of security for the future. And Simon's "Family Unit" Policy with the "Yorkshire" guarantees them *all* a future — if the worst should happen.

Happiness in *your* family too—but for how long? If you or *your wife* should die, how would the rest of the family fare? A Yorkshire "Family Unit" policy provides for both these eventualities in a comprehensive way at a sensible premium. Just ask for a leaflet at your local "Yorkshire" branch and then see the manager. He'll be glad to tell you why . . .

it's **YORKSHIRE** for **INSURANCE**

THE YORKSHIRE INSURANCE COMPANY LIMITED

Chief Offices: Rougier Street, YORK
and Becket House, 36-37 Old Jewry, LONDON, E.C.2.

Branches and Agencies throughout the world

Please send me details of the Family Unit Policy, without obligation.

Name.....

Address.....

J.B.

SMALL ADVERTISEMENTS

Rate: 9d. per word. Minimum charge 12/-.
Box No. 2/- extra.

Advertisements must be prepaid and all copy must be received by the 4th of the month for insertion in the following month's issue. The Publishers cannot be held liable in any way for printing errors or omissions, nor can they accept responsibility for the bona fides of advertisers. (Replies to Box numbers should be addressed to: Box No.—, *The Radio Constructor*, 57 Maida Vale, London, W.9.)

SERVICE SHEETS. Radio, Television, Tape Recorders 1925-1968, by return post, from 1s. with free fault-finding guide. Catalogue 6,000 models 2s. 6d. S.A.E. enquiries.—Hamilton Radio, 54c London Road, Bexhill, Sussex.

FOR SALE. Oscilloscopes—Galvanometers—Evershed & Vignolles Meggers—Relays—Uniselector Switches—Solennoids. Also other items and components. Free list. Stamp please.—R. & E. Mart, Box 9 G.P.O., Tunbridge Wells, Kent.

ILLUSTRATED CATALOGUE No. 17. Manufacturers Surplus and New Electronic Components including Semiconductors. 3/- Post Free. Arthur Sallis Ltd., 28 Gardner Street, Brighton.

WHY BUILD A POWER SUPPLY, when you can buy one for only 25/-, plus 2/6d p. and p. Mains input 230V a.c. 250V, 100mA d.c. out. Fused. 6.3V at 3 amp. 7.3V at 3 amp. ISHERWOODS ELECTRONICS, 98/100 Northgate, Blackburn, Lancs.

BRIGHTEN UP YOUR ADVERTISING! Break the ice with a cartoon, "tailor made" for your product. Reasonable charges.—Box No. F294.

5 TON FACTORY CLEARANCE. Radio, T.V., elec. components in 27s. 6d. mixed parcels. Post free. Example: resistors, condensers, pots, speakers, coax, coils, fibre washers, valves, over a dozen different types, tuning knobs, grommets, sleeving, IFS, Paxalin, wire, rectifiers. Lots of other items. Pot Luck. Postal orders to: P. L. Newton, 16 Shallcross Crescent, Hatfield, Herts.

BOOKS FOR SALE. *Alfred Nobel E. Bergengren* £1, *Radio-isotope Laboratory Techniques R. A. Faïres*, 10s. *Atomic Medicine Behrens*, £1. *Medical Radiation Biology Ellinger*, 30s. *Physics in Medical Radiology Russ, Clark & Pelc*, 7s. 6d. *Disease & its Conquest Hollis*, 7s. 6d. *Earth's Envelope T. Lobsack*, 15s. *The Atomic Submarine C. Blair*, 7s. 6d. *Astro-and exploration D. R. Bates*, £1. *Once round the Sun Story of the I.G.Y., Fraser*, 10s. *Earth Satellite P. Moore*, 7s. 6d. *Frontier to Space E. Burgess*, 5s.—Box No. F316.

JOIN THE INTERNATIONAL S.W. LEAGUE. Free Services to members including Q.S.L. Bureau. Amateur and Broadcast Translation. Technical and Identification Dept.—both Broadcast and Fixed Stations, DX Certificates, contests and activities for the SWL and transmitting members. Monthly magazine, *Monitor*, containing articles of general interest to Broadcast and Amateur SWLs, Transmitter Section and League affairs, etc. League supplies such as badges, headed notepaper and envelopes. QSL cards, etc., are available at reasonable cost. Send for League particulars. Membership including monthly magazine, etc. 35s. per annum.—Secretary, ISWL, 60 White Street, Derby.

VALVES, COMPONENTS, MAGAZINES for disposal. S.A.E. list. Toms, "High View". Frittenden, Cranbrook, Kent.

continued on page 202

BENTLEY ACOUSTIC CORPORATION LTD.

38 Chalcot Road, Chalk Farm, London, N.W.1.
The Old Gloucester Station
Littlehampton, Sussex
GLOUCESTER ROAD
LITTLEHAMPTON, Sussex
PR1mrose 9090

Please forward all mail orders to Littlehampton PHONE 6743

524G	7/-	ECC84	5/6	PC88	9/9	U801	17/6	AF116	3/-	GET896	4/6
6AT6	4/-	ECC85	5/-	PC95	8/9	U4020	6/9	AF117	3/4	GET897	4/6
6ZOL2	12/6	ECC88	7/-	PC97	7/9	UABC80	5/9	AF119	3/-	QAB1	4/6
6F1	5/9	ECC189	9/6	PC900	8/9	UBC81	6/6	AF125	3/6	QAB5	1/9
6F23	12/3	ECF80	6/6	ECF82	6/6	UBF80	5/9	AF127	3/6	OA182	2/6
6L6GT	7/9	ECF82	6/6	PCCR5	6/9	UBF89	6/3	AF139	11/-	OA200	1/-
10F1	15/-	ECF86	9/-	PCCR8	11/-	UC52	8/6	AF180	9/6	OC22	5/6
10P13	15/6	ECH42	9/6	PCCR9	9/6	UCC84	8/6	AF212	5/6	OC23	1/6
20D1	13/-	ECH81	5/3	PCCR189	9/3	UCC85	6/6	ASV29	10/-	OC24	17/6
20L1	13/-	ECH83	7/9	PCF80	6/6	UCH21	9/-	BA129	2/6	OC25	5/6
20P4	17/6	ECH84	6/6	PCF82	6/3	UCH22	9/6	BA130	2/6	OC28	5/6
30C15	13/6	ECL80	6/6	PCF86	8/6	UCH21	9/6	BC107	4/6	OC30	7/6
30C17	13/6	ECL82	6/6	PCF86	8/6	UCH21	9/6	BC108	5/6	OC35	10/6
30C18	8/9	ECL83	9/6	PCF801	7/6	UCL82	7/6	BC109	4/6	OC36	7/6
30F5	11/9	ECL86	7/9	PCF802	9/3	UCL83	9/6	BC109	4/6	OC38	7/6
30F12	15/-	EF22	12/6	PCL82	6/6	UF41	9/3	BCY10	5/6	OC38	11/6
30FL14	12/6	EF37A	7/6	PCL83	8/9	UF42	9/3	BCY12	5/6	OC41	10/6
30L11	12/6	EF41	9/6	PCL84	7/3	UF80	6/9	BCY33	5/6	OC44	2/6
30L15	13/9	EF80	4/6	PCF85	8/3	UF85	7/3	BCY34	5/6	OC45	1/9
30L17	13/6	EF85	4/9	PCL86	8/3	UF86	6/9	BCY38	5/6	OC46	3/6
30P4	12/6	EF86	6/6	PFL200	12/6	UF89	5/9	BF126	6/6	OC70	2/3
30P4MR	17/6	EF89	4/9	PL36	9/9	UL41	9/6	BFY50	5/6	OC71	2/6
30P12	13/6	EF183	6/6	PL81	7/6	UL84	6/6	BFY51	4/6	OC72	2/6
30P19	11/6	EF184	6/3	PL82	5/9	UM80	5/6	BFY52	5/6	OC75	2/6
30P11	15/6	EH90	6/6	PL83	6/6	UV41	6/6	BFY63	4/6	OC79	2/6
30P13	15/6	EL33	12/6	PL84	6/6	UV85	5/6	BFY100	3/6	OC78	3/6
30P14	15/6	EL41	9/3	PL500	12/3	ZN404	6/6	BY126	6/6	OC77	3/4
CL33	19/6	EL84	4/6	PL504	13/6	ZN2297	4/6	BY234	4/6	OC78	3/6
CV31	7/9	EL95	5/6	PY32	9/6	ZN2369A	4/3	BY236	4/6	OC78D	3/6
DY87	5/9	EM80	5/9	PY33	9/6	ZN2366	20/-	BY238	4/6	OC81	2/6
EBCC	12/6	EM81	6/6	PY81	5/6	AZ13	5/6	BY211	5/6	OC81D	2/6
EABC80	6/6	EM84	6/6	PY82	5/6	AC107	3/6	BY212	5/6	OC82	2/3
EAF42	8/3	EM85	11/6	PY83	5/6	AC113	5/6	BY213	5/6	OC83	2/3
EB91	2/3	EM87	7/3	PY88	6/3	AC126	2/6	BY215	5/6	OC84	4/6
EBC41	8/6	EY51	6/6	PY800	6/6	AC127	2/6	GET103	4/6	OC123	4/6
EBC81	6/6	EY86	6/6	PY801	6/6	AC128	2/6	GET113	4/6	OC169	3/9
EBF80	5/9	EY87	6/6	U25	13/6	AC154	5/6	GET116	7/6	OC170	2/6
EBF83	7/6	EZ40	7/9	U26	10/6	AC156	4/6	GET119	4/6	OC171	3/4
EBF89	5/9	EZ93	3/9	U33	13/6	AC157	5/6	GET173	8/6	OC172	4/6
EF91	3/3	EZ81	4/6	U45	15/6	AD140	8/6	GET587	8/6	OC200	5/6
EC92	6/6	KT88	29/6	U191	12/6	AD149	8/6	GET873	4/6	OC202	5/6
ECC81	4/6	KTW62	12/6	U251	12/6	AD162	9/6	GET887	4/6	OC203	5/6
ECC82	4/6	PABC80	7/6	U301	11/6	AF114	4/6	GET889	4/6	OC205	7/6
ECC83	4/6	PC86	10/6	U404	7/6	AF115	3/6	GET890	4/6		

Terms of business: Cash with order only. No C.O.D. Post/Packing 6d. per item. Orders over £5 post free. All orders despatched same day as received. Complete catalogue including transistor section and components with terms of business 6d. Any parcel insured against damage in transit for 6d. extra. Business hours: 9 a.m. - 5.30 p.m. Saturdays 9 a.m. - 1 p.m.

TECHNICAL TRAINING by ICS IN RADIO, TELEVISION AND ELECTRONIC ENGINEERING

First-class opportunities in Radio and Electronics await the ICS trained man. Let ICS train YOU for a well-paid post in this expanding field.

ICS courses offer the keen, ambitious man the opportunity to acquire, quickly and easily, the specialized training so essential to success. Diploma courses in Radio/TV Engineering and Servicing, Electronics, Computers, etc. Expert coaching for:

- * C. & G. TELECOMMUNICATION TECHNICIANS CERTS.
- * C. & G. ELECTRONIC SERVICING
- * R.T.E.B. RADIO AND TV SERVICING CERTIFICATE
- * RADIO AMATEURS EXAMINATION
- * P.M.G. CERTIFICATES IN RADIOTELEGRAPHY

Examination Students Coached until Successful.

NEW SELF-BUILD RADIO COURSES

Build your own 5-valve receiver, transistor portable, signal generator, multi-test meter and professional-type valve voltmeter—all under expert guidance

POST THIS COUPON TODAY and find out how ICS can help YOU in your career. Full details of ICS courses in Radio, Television and Electronics will be sent to you by return mail.

MEMBER OF ASSOC. OF BRITISH CORRESPONDENCE COLLEGES.

INTERNATIONAL CORRESPONDENCE SCHOOLS

Dept. 248, Intertext House, Parkgate Road, London, S.W.11.

NAME

ADDRESS

Block Capitals Please

10.68

NEW STYLE SELF-BINDER

for "The Radio Constructor"

The "CORDEX" Patent Self-Binding Case will keep your issues in mint condition. Copies can be inserted or removed with the greatest of ease. Rich maroon finish, gold lettering on spine.

Specially constructed Binding Cords are made from Super Linen of great strength, very hard twisted and twice doubled. They are attached to strong RUSTLESS Springs under tension, and the method adopted ensures PERMANENT RESILIENCE of the Cords. Any slack that may develop is immediately compensated for, and the Cords will always remain taut and strong. It is impossible to overstretch the springs, as a safety check-device is fitted to each.

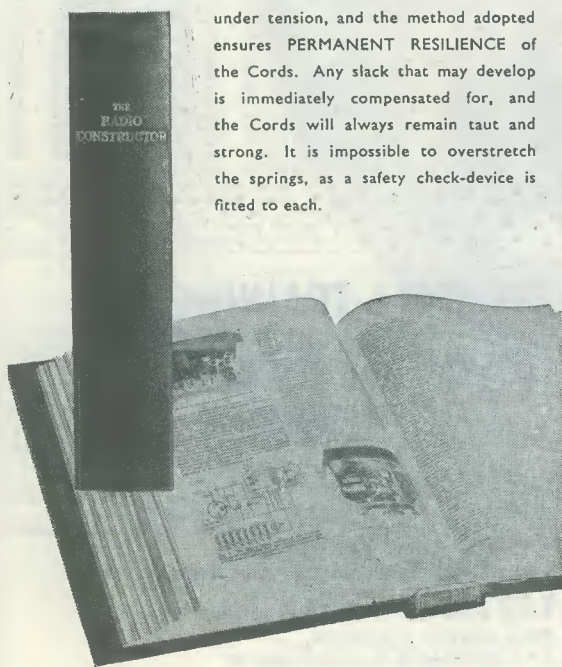

PRICE **15/-** Post Free

Available only from:—

Data Publications Ltd.
57 Maida Vale London W9

SMALL ADVERTISEMENTS

continued from page 201

WANTED TO PURCHASE. Denco coil turret, type CT7/B Urgently required to complete construction of receiver. N. G Edmunds, 16 Dawlish Drive, Styvechale, Coventry, Warwickshire.

"MEDIUM WAVE NEWS" Monthly during DX season—Details from: K. Brownless, 7 The Avenue, Clifton, York.

CAR ELECTRONIC IGNITION SYSTEMS. If you want to cut petrol consumption (up to 6 m.p.g. extra) and cut plug and point wear, these units do it. If you want more, you also get smoother and stronger pulling at low speeds and better sparks at high speeds. Unbelievable winter starting. Soon pays for itself. Guaranteed new and tested. Offered at only £12 (nearly half price). Only 3 connections. State earth polarity. 12V only. Orders to: R. Turner, 70 Jarrett Avenue, Wainscott, Rochester, Kent.

ARE YOU A MOTORING ENTHUSIAST? The Seven Fifty Motor Club caters for all types of motor sport—racing, rallies, hill climbs, etc. Monthly Bulletin free to members. For full details write to: The General Secretary, Colin Peck, "Dancer's End," St. Winifred's Road, Biggin Hill, Kent.

FOR SALE: 1 cwt. electronic components, chassis, (resistors, capacitors, pots, etc.). View London W.2. £3. Buyer collects. Telephone: Mr. Fowler, 01-723-9584. 9 a.m. to 6 p.m.

GENUINE BRAND NEW Silicon Planar transistors. Postage 6d. 2N2369, 650MHz 4/6d., BC108 3/3d., 600V PTRV 1 amp. silicon rectifiers 4/-, E88CC valves 5/6d. Metal oxide and H.S. resistors. Details and lists, s.a.e. Box No. F343.

WANTED—RETAIL OUTLETS for new/surplus radio—electronic spares. Excellent profits. Details from Box No. F344.

TECHNICAL DRAWINGS, Artwork, etc. Electronic and Radio Circuits a speciality. Moderate charges.—B. P. Meany, 43 Forest Road, Worthing, Sussex.

DIGITAL CIRCUIT BLOCKS. M.E.L. 100 kHz range, mostly new. Approximately 150 including 18 PS, OS; 20 FF; 55 gates; 54 amplifiers, EF. Offers? Box No. F345.

JAMSISTOR. Circuit of experimental jamsistor free with each 1 in. cube micro-transmitter at 50/-. (Superior to WO-11 type). S.a.e. details. Box No. F346.

OSCILLOSCOPE FOR SALE. Cossor 1049 Mk. 3, 4 in. twin beam/amps, intensity modulation, nine time ranges, blue/silver. All functions fully operational. £45 o.n.o. Barrett, Bridge Cottage, St. Wilfrid's Road, Burgess Hill, Sussex. Burgess Hill 6662.

FOR SALE: MORSE OSCILLATOR SET. Transistorised, type D, key, on base 8½ in. x 9½ in., with headphones. £3. Box No. F347.

BOOK BARGAINS TO CLEAR. "The Yachtman's Bedside Book", Snoxell, 25/-. "The Story of Atomic Energy", Soddy, 12/6d. "Invitation to Skiing", Iselin and Spectorsky, 20/-. "The Upper Atmosphere", Massey and Boyd, 50/-. "Outlook"—simple weather forecasting. White, 7/6d. "Basic Principles of Marine Navigation", Moore, 7/6d. "Telegraphy", Freebody, 60/-. "The Book about Weather", Mee, 7/6d. Box No. F348.

(continued on page 203)

SMALL ADVERTISEMENTS

continued from page 202

POSTAL ADVERTISING? This is the Holborn Service. Mailing lists, addressing, enclosing, wrapping, facsimile letters, automatic typing, copy service campaign planning, design and artwork, printing and stationery. Please ask for price list.—The Holborn Direct Mail Company, Capacity House, 2-6 Rothsay Street, Tower Bridge Road, London, S.E.1. Telephone: 01-407-1495.

WANTED. 2 spools to take 500 ft. of standard 8 mm cine film.—Note 500 ft., not 400 ft! Box No. F349.

FOR SALE. Golay Lever Escapement Navigation watch, with external, rotatable, navigation ring, graduated to 360°. In wooden case, 4 in. x 3½ in. x 2 ½ in. £10. Box No. F350.

PROPERTIES for sale and to let in London and suburbs. Apply to Maggs & Stephens, Estate Agents, 229 Maida Vale, London, W.9. MAIda Vale 8123.

FOR SALE. Quantity Meccano parts, make excellent present. S.A.E. for details. Price around £10. Box No. F351.

TO CLEAR. 3000V d.c. 0.5µF capacitors, 2½ in. x 1½ in. x 6in. with porcelain insulators, 3/6d. each. 88Htoroid coils, new, wax covered, 5/- each. Heathkit Balun Coil set, B-1U, assembled, £5. Box No. F352.

ESSEX GARDENERS. Buy your bedding and rock plants, shrubs, etc., also cacti from May's Nurseries, 608 Rayleigh Road, Hutton, Brentwood, Essex. Callers only. Monday to Saturday.

RADIO HAMS. For sale, R.107 set, Good condition, £30 or nearest; Single and twin Tannoy speakers; power generator (converter) S.E.R.70; 2 converter units type S454B; carbon microphones; radio receiver VC 453B; Offers? Box No. F353.

INNOVATION IN DX CLUBS ANNOUNCED! Formed in October, 1965, the Radio New York Worldwide Listeners Club now has 3,600 members in 86 countries! A unique club offering shortwave listeners monthly magazines containing listening tips and technical features, numbered wallet-sized membership cards and gold 8½ in. by 11in. membership certificates. Multi-lingual report forms available for cost of postage. "We must be doing something right!" Find out . . . join now!" Send 7s. 2d. (crossed domestic money order) for one year's membership to: The Radio New York Worldwide Listeners Club, 485 Madison Avenue, New York 10022, U.S.A.

FULL-TIME COURSE IN BASIC ELECTRONICS. A NINE MONTH COURSE, starting September, for those wishing to work in Radio, Television, Computers or Automatic Control. The course leads to City and Guilds certificates and is ideal for school leavers, for whom, in most cases, no fee is payable. For details of this, or part time courses in Colour T.V., etc., write to Section 47/58 SOUTHALL COLLEGE OF TECHNOLOGY, Beaconsfield Road, Southall, Middlesex.

SITUATION VACANT

RADIO COMMUNICATIONS DESIGNER. We need the services of a Radio Communications Designer to design transmitting and receiving equipment to our specification. Telephone: Operation and Transport Services, East Grinstead 21742.

NOVOTEST—DEFINITELY THE BEST

Most compact and versatile multi purpose testmeter on the market. Beautifully designed in 5 colour scale and wording. Measures 6 in. x 4 in. x 2 in. 10 Measuring ranges—50 values. Write for descriptive literature to:

R. W. (I & C) Ltd.—P.O. Box 7—Hartlepool
Co. Durham, quoting REF: RC
Sole distributors for the U.K.

PLAIN-BACKED NEW STYLE SELF-BINDERS

for your other magazines

(max. format 7½" x 9½")

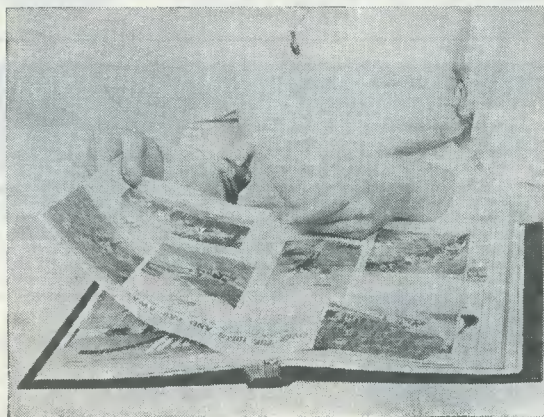

The "CORDEX" Patent Self-Binding Case will keep your copies in mint condition. Issues can be inserted or removed with the greatest of ease. Rich maroon finish. Specially constructed Binding Cords are made from Super Linen of great strength, very hard twisted and twice doubled. They are attached to strong RUSTLESS Springs under tension, and the method adopted ensures PERMANENT RESILIENCE of the Cords. Any slack that may develop is immediately compensated for, and the Cords will always remain taut and strong. It is impossible to overstretch the springs, as a safety check-device is fitted to each.

COLOURS: MAROON OR GREEN

(Please state choice)

PRICE 14/6 Post Free

Available only from:—

Data Publications Ltd.
57 Maida Vale London W9

CHASSIS and CASES by



H. L. SMITH & CO. LTD.
287/9 Edgware Road
London. W2
TEL: 01-723 5891

BLANK CHASSIS—Same day Service

Of over 20 different forms made up to YOUR SIZE.
(Maximum length 35", depth 5".)

SEND FOR ILLUSTRATED LEAFLETS or order straight away, working out total area of material required (including waste) and referring to table below which is for four-sided chassis in 16 s.w.g. aluminium.

48 sq. in.	5/-	176 sq. in.	10/4	304 sq. in.	15/8
80 sq. in.	6/4	208 sq. in.	11/8	336 sq. in.	17/-
112 sq. in.	7/9	240 sq. in.	13/-	368 sq. in.	18/4
144 sq. in.	9/-	272 sq. in.	14/4	and pro rata	
	P. & P. 3/-		P. & P. 3/6		P. & P. 4/6

Discounts for quantities. More than 20 different sizes kept in stock for callers.

FLANGES ($\frac{1}{4}$ " or $\frac{3}{8}$ "), 6d. per bend.

STRENGTHENED CORNERS, 1/- each corner.
PANELS

Any size up to 3ft at 6/- sq. ft. 16 s.w.g. (18 s.w.g. 5/3).
Plus postage and packing

CASES SILVER HAMMERED FINISH ALUMINIUM, HAMMERED FINISH

Type	Size	Price	Type	Size	Price
N	8 x 6 x 2"*	18/-	W	12 x 7 x 7"	37/6
N	6 x 6 x 3"	17/6	W	15 x 9 x 8"	48/6
N	4 x 4 x 2"	11/-	Y	8 x 6 x 6"	29/-
U	4 x 4 x 4"	11/-	Y	12 x 7 x 7"	45/-
U	5 1/2 x 4 1/2 x 4 1/2"	17/-	Y	13 x 7 x 9"	50/6
U	8 x 6 x 6"	23/-	Y	15 x 9 x 7"	53/6
U	9 1/2 x 7 1/2 x 3 1/2"	24/-	Z	17 x 10 x 9"	72/6
U	15 x 9 x 9"	49/-	Z	19 x 10 x 8 1/2"	78/-
W	8 x 6 x 6"	23/-			

*Height
Type N has removable bottom, Type U removable bottom or back, Type W removable front, Type Y all screwed construction, Type Z removable back and front.

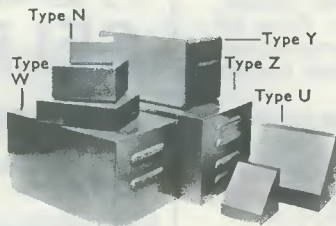

HIGH GLOSS METALLIC HAMMERED ENAMEL

'Makes fantastic difference to Panels' so say

hundreds of enthusiastic users. "Crackle" pattern appears like magic. Dries hard glossy finish. Scratch-proof, resists heat and liquid. Simply brush-on. No undercoat. Air dries 15 mins. Lt. & Dk. Blue; Bronze; Silver; Green; Black. Send for details or send 8/- (plus 1/9 post.) for 3pt. Trial Tin, colour samples and instructions.

FINNIGAN SPECIALITY PAINT MANUFACTURERS,
DEPT. RC, STOCKSFIELD, NORTHUMBERLAND. Tel. 2280.



BRUSH
OR SPRAY-ON
QUICK DRYING

20 Suggested Circuits

by G. A. FRENCH

48 pages
Price 3/6d.
Data Book Series No. 15
Postage 5d.

This book contains the first 20 circuits to be published in the very popular series of the same name appearing in *The Radio Constructor*.

The Contents include: simple and inexpensive two-valve capacity bridge, short wave regeneration preselector, one-valve speech operated switching circuit, transformer ratio analyser, series noise limiter, receiver remote mains on-off control, and many others; covering subjects ranging from electronic laboratory equipment to a simple 2-Stage Gram Amplifier.

DATA PUBLICATIONS LTD., 57 MAIDA VALE, LONDON, W.9.

"V" NOTCHES

G. P. O.
TYPE
RELAY
CONTACT
SPRINGS



WANTED

Contact springs as shown
BEST PRICES PAID

S.a.e. to "Lanco", 76 Sedgemoor Road,
Willenhall, Coventry, Warwickshire

NOW AVAILABLE ... BOUND VOLUME No. 21 of "The Radio Constructor"

AUGUST 1967 to JULY 1968
Comprising 792 pages plus index

FOR YOUR LIBRARY PRICE 35/- Postage 4/6

Special discount of 10/- for regular readers

As a further service to regular readers, it is no longer necessary to return the complete issues making up a volume, to qualify for the special discount.

Just cut the heading from each month's contents page, including title and month of issue, and this will be sufficient evidence of readership to qualify for the discount.

Thus regular readers will still retain their old copies for workbench use, while having a splendid bound volume containing issues in mint condition.

PRICE 25/- Postage 4/6

Limited Number of Volume 20 (August 1966-July 1967) still available. Price : 32/6, postage 4/6.

Available only from:

DATA PUBLICATIONS LTD., 57 MAIDA VALE, LONDON, W9

THE RADIO CONSTRUCTOR

Price 3/- each, postage 6d.

Annual Subscription 42/-, post free.

Bound Volumes Vol. 20 August 1966 to July 1967 32/6, postage 4/6.
Vol. 21 August 1967 to July 1968 35/-, postage 4/6.

Cordex Self-Binders With title "The Radio Constructor" on spine, maroon, 14/-, postage 1/6.
With no title on spine, maroon or green, 13/6, postage 1/6.

DATA BOOK SERIES

- DB5 TV FAULT FINDING**
124 pages. Price 8/6, postage 8d.
- DB6 THE RADIO AMATEUR OPERATOR'S HANDBOOK**
64 pages. Price 5/-, postage 5d.
- DB14 SHORT WAVE RECEIVERS FOR THE BEGINNER**
72 pages. Price 6/-, postage 6d.
- DB15 TWENTY SUGGESTED CIRCUITS**
48 pages. Price 3/6, postage 5d.
- DB16 RADIO CONTROL FOR MODELS**
192 pages. Price 15/-, postage 1/-.
- DB17 UNDERSTANDING TELEVISION**
512 pages. Price 37/6, postage 3/-

PANEL-SIGNS TRANSFERS

Six sheets in each set

Set 3: WORDING—White

Set 4: WORDING—Black

Set 5: DIALS—Control Panels have a clear background

Set 6: DIALS—Control Panels have a black background

Price per set 4/6, postage 4d.

I enclose Postal Order/Cheque for.....in payment for.....

NAME

ADDRESS

(Please use Block Capitals for both name and address)

Postal Orders should be crossed and made payable to Data Publications Ltd.

Overseas customers please pay by International Money Order

All publications are obtainable from your local bookseller

Data Publications Ltd., 57 Maida Vale, London W.9

ENGLANDS LEADING COMPONENT & EQUIPMENT CENTRES

SOLID STATE-HIGH FIDELITY AUDIO EQUIPMENT

Audio Equipment developed from Dinsdale Mk.II—each unit or system will compare favourably with other professional equipment selling at much higher prices.

COMPLETE SYSTEMS FROM £15.5.0

THE FINEST VALUE IN HIGH FIDELITY—CHOOSE A SYSTEM TO SUIT YOUR NEEDS AND SAVE POUNDS

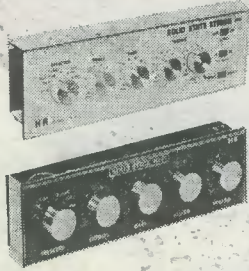

All units available separately.

SEND FOR 16 PAGE BROCHURE (No. 21) TODAY!
DEMONSTRATIONS DAILY AT '303' EDGWARE ROAD

Acclaimed by everyone THE MAYFAIR ELECTRONIC ORGAN

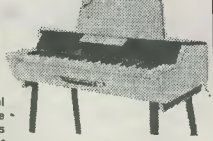

A completely new development in portable electronic musical instruments and a new field for the home constructor. The 'MAYFAIR' produces a multitude of the most pleasing sounds with a wide range of tone colours suitable for classic or popular music. The organ is fully polyphonic, that is full chords can be played over the entire keyboard. Supplied as a kit of parts including 156 transistors, printed circuit panels, special fully sprung and depth of touch adjusted keyboard, attractive vinyl covered cabinet with carry handle. A complete detailed and illustrated construction manual is provided with circuits and full parts list. Cost can be saved by purchasing the components packet by packet. All parts supplied are fully guaranteed. Full after sales service.

A new source of construction for the keen electronics fan either amateur or professional. Once built the 'MAYFAIR' will then provide years of enjoyable entertainment. **TOTAL COST 99 Gns.**

ORGAN COMPONENTS	Deferred terms available.	BUILT AND TESTED
We carry a comprehensive stock of organ components for TRANSISTOR AND VALVE FREE PHASE designs.	COMPLETE KIT Deposit £29.19.0. 12 monthly payments of £7. TOTAL £113.19.0.	Deposit £36.8.0 & 12 monthly payments of £9. Total £144.8.0.
Ask for BROCHURE 9	Call in. See it and play it yourself.	EXPORT ENQUIRIES INVITED

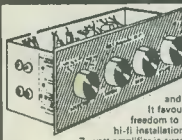

TRANSISTOR AMPLIFIER

INTEGRATED 7 WATT AMPLIFIER & PREAMPLIFIER—MAY
With full Bass Treble and Volume Controls

A brilliant new design suitable for home or portable installations. For use with magnetic and crystal/ceramic cartridges, radio tuners, microphones, tape head (play) and auxiliary inputs. Output is for 3-16 ohm speakers. It favours the user in so many ways—with fantastic power, with far greater adaptability, with freedom to operate it from batteries or mains power supply unit (the new PS.20 is ideal for this), hi-fi installations, electronic guitars and organs, P.A. installations, intercom, systems, etc. This true 7-watt amplifier is supplied ready built, tested and guaranteed.

For complete listening satisfaction. FOR ONLY £8/10/0 P.P. 4/- (OPTIONAL MAINS UNIT PS.20 8/2/2, P.P. 3/-). Illustrated Brochure No. 12.



BRITISH MADE CAR RADIOS

A fine precision engineered car radio that's perfect company for long hours on the road. So easy to install and operate—and the price is exactly right. Has quick push-button operation for immediate station selection and choice of Medium or Long wave frequency. Manual tuning facilities. Push-button control. Output of 34 watts ensures crisp, top quality sound even at high motoring speeds. Price includes 7" x 4" speaker, full accessories and instructions.

POSITIVE OR NEGATIVE EARTH **EASI-TUNE £12.12.0 pp. 4/6**
AUTOBAHN MANUAL as the EASI-TUNE, but with a single MW/LW Push Button. **£10.10.0 pp. 4/6**
CAR AERIALS * 3-Section Single Hole Wing or Boot Mounting 18/8 Brochure 15
Multi Section fully disappearing type with locking device, single hole mounting 35/- Post free with Car Radio or pp. 2/6 separately.

BUILD THESE PRACTICAL DESIGNS

I.C.F.M. TUNER	£5.2.6.	40B
Switched F.M. Tuner	£3.17.6.	39B
Fluorescent Camping Light	£3.2.6.	43

Let us have your enquiries for parts for current PW and PE designs. S.A.E. PLEASE.

NEW MODELS NOMBREX TRANSISTORISED Test Equipment

MODEL	PRICE	Leaflet
22 Power Supply	14 0 0	22
30 Audio Generator	19 10 0	24
31 R.F. Generator	12 10 0	25
32 C.R. Bridge	10 10 0	26
33 Inductance Bridge	20 0 0	29

Send for descriptive illustrated Brochure.

DO IT YOURSELF MW/LW PORTABLE

New printed circuit design with full power output. Fully tunable on both mw/lw bands. 7 transistors plus diode, push-pull circuit. Fitted 5 inch speaker, large ferrite aerial and Mullard transistors. Easy to build with terrific results. All local and Continental stations.
TOTAL COST £6.19.6. P.P. 4/6
TO BUILD Send for Brochure 1

MULLARD 1 WATT AMPLIFIER WITH VOLUME CONTROL

Suitable 7 x 4 inch 3 ohm speaker 17/6
Ideal for Portable Record Players, Inter-Comms, Baby Alarms etc. **45/-** pp. For 9 Volts operation. 3/6d.

ITS SO EASY TO BUILD TO PROFESSIONAL STANDARDS

To get the best out of your MAGNAVOX STUUDIOMATIC DECK Type 363, you need a MARTIN RECORDAKIT. This comprises a special high quality 8 valve amplifier and pre-amplifier which comes to you assembled on its printed circuit board, together with necessary transformers, switches, control knobs—in fact everything needed down to the last screw FOR MAKING A SUPERB TAPE RECORDER, which, when built, will compare favourably with instruments costing twice as much, yet you need no experience or technical skill to bring this about! THE INSTRUCTIONS MANUAL MAKES BUILDING EASY AND SUCCESS ASSURED.

TWO TRACK Deck, Amplifier, Cabinet and Speaker. Complete kit with MICROPHONE 7 in 1,200 ft. tape, spare spool. Today's value **£55.** OUR PRICE **36 gns.**

FOUR TRACK Deck, Amplifier, Cabinet and speaker. Complete kit with MICROPHONE 7 in 1,200 ft. tape, spare spool. Today's Value **£80.** OUR PRICE **39 gns.**

P.P. 2/6
ALL UNITS AVAILABLE SEPARATELY. Both models. ASK FOR BROCHURE 6.

VHF-FM SUPERHET TUNER MKII

*5 MULLARD TRANSISTORS & 4 DIODES * 300 Kc/s BANDWIDTH * PRINTED CIRCUIT CONSTRUCTION * HIGH FIDELITY REPRODUCTION MONO AND STEREO * MATCHES AUDIO MK II EQUIPMENT

A popular VHF FM Tuner now used throughout the country for quality reception of monophonic and, with the decode stereophonic broadcast. There is no doubt about it—VHF FM gives the real sound. Excellent stability economically priced. **TOTAL COST £6.19.6.** **DECODER £5.19.6.** (CABINET 20/- EXTRA) ASK FOR LEAFLET 3.

TRANSISTORS, RECTIFIERS, ZENERS, SCR's, TUNNEL DIODES, FIELD EFFECT TYPES, VALVES, CRYSTALS
New 1968 32-page Booklet
Price 1/- Post Paid
Circuits with Data, Details and Prices of over 2000 different types. This booklet is a must for every enthusiast. MANUFACTURERS — DISTRIBUTORS. We also publish a QUANTITY, SEMI-CONDUCTOR BULLETIN. Please write to us for your copy.

NEW — MALLORY LONG LIFE MERCURY BATTERIES

60% OFF LIST PRICES

* RM12 1.35 volts 3600 mA/H OUR PRICE 6/- each size 2" x 3/4" dia.

* RM25 10.35 volts 350 mA/H Pack of 6. Size 2 1/2" x 1 1/2" dia. OUR PRICE 10/- each

Easily split into eight 1.35v cells. These cells are ideal for any application where SMALL SIZE HIGH CAPACITY and LONG LIFE are required. QUANTITY QUOTATIONS WRITE OR PHONE EXTN. 2.

GARRARD DECKS

BRAND NEW All below list price.

2025 Mono/Stereo	£ 8 19 6
300 LW with STANC	9 11 6
SP25 MK II	12 12 0
LAB80 Mk II	26 0 0
AT65	10 19 6
AT60 Mk II	13 19 6
40 Mk II	11 10 0
3500 Mono/Stereo	14 10 0
401	27 15 0
AP75	21 10 0
SL85	13 10 0
SL85	16 19 6
SL85	32 10 0
SL75	39 10 0
SL85	13 13 0

Send for illustrated brochure T.16.17
Complete range of accessories available

Hi-Fi equipment to suit EVERY POCKET

Ask for Hi-Fi Stock List Leaflet 16.17
VISIT OUR NEW HI-FI CENTRE at 309 EDGWARE RD.

for all leading makes
AMPLIFIERS
TUNERS
DECKS
SPEAKERS
MICROPHONES
SYSTEMS
ALL WITH DISCOUNTS
IT WILL PAY YOU TO PAY US A VISIT!

Fully Illustrated CATALOGUE

COMPLETELY NEW 9th EDITION (1968)

The most COMPREHENSIVE—CONCISE—CLEAR—COMPONENTS CATALOGUE

Complete with 10/- worth discount vouchers FREE WITH EVERY COPY.

- * 32 pages of transistors and semi-conductor devices, valves and crystals.
- * 200 pages of components and equipment.
- * 65 pages of microphones, decks and Hi-Fi equipment.

6,500 ITEMS
300 BIG PAGES **Send today 8/6** Post Paid

HENRY'S RADIO LTD (HR)
OPEN MON-SAT. 9 a.m.-6 p.m. THURS. 9 a.m.-1 p.m.

303 Edgware Road, London, W.2. Mail Order Dept all types of Components, Organ Dept. (01) 723-1008/9
309 Edgware Road, London, W.2. High Fidelity Sales, P.A. and Test Equipment, Record Decks (01) 723-8963